



2012

UK Product Catalogue

Printed and distributed by KORG UK Ltd



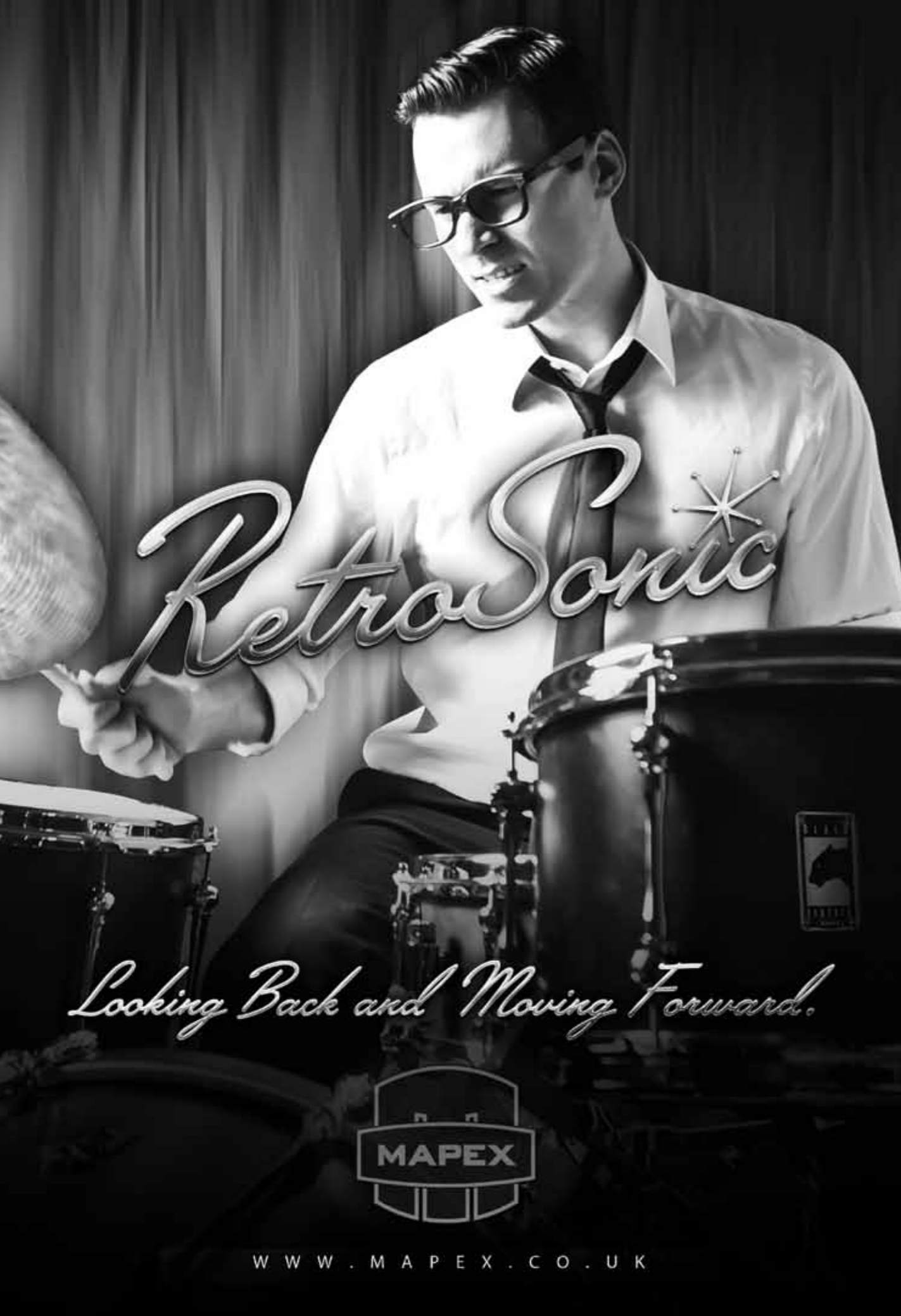

Looking Back and Moving Forward.



WWW.MAPEX.CO.UK

BLACK PANTHER COLLECTION

PUSHING CONCEPTUAL BOUNDARIES

Based on its successfully distinctive snare drum series, Mapex has taken this highly progressive design philosophy, extended it across an entire collection of unique drums and created the Mapex Black Panther drum Series.

Black Panther drums feature boldly unique shell formulas with specially designed bearing edge profiles to create distinctive tone and voice.

With the Black Panther Series, Mapex speaks to the artistic side of every drummer by giving them drums that bring life to the sound they have only heard in their dreams.

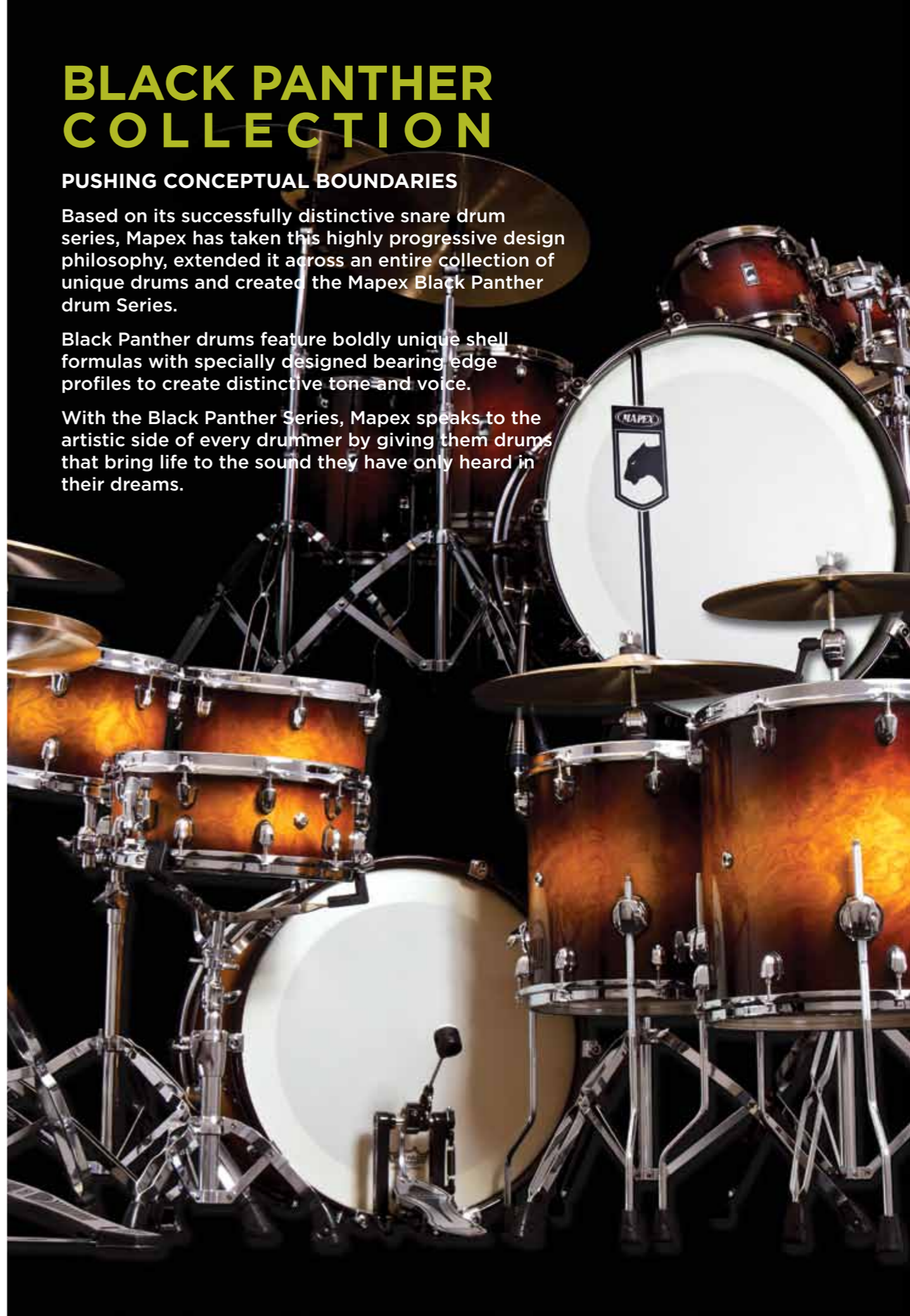



"You can probably tell already that we at iDrum loved this kit. Visually and sonically it just works and can be applied to so many different genres thanks to an incredible tuning range and dynamic sensitivity. The resonance of the floor tom in particular is something to behold and the exceptional volume, projection and growl of this kit as one complete voice is really special"

iDRUM MAGAZINE

THE RETROSONIC

LOOKING BACK. MOVING FORWARD.

The third powerhouse in the Black Panther collection is now here, everybody please welcome, the **RETROSONIC!**

The first thing to notice about the new addition are the shells; hand selected, highly figured semi-gloss Walnut, beautifully dressed with the sleek and stylish Retrosonic tube lug which perfectly match it's snare drum inspiration. The finish and hardware combine to give a distinctive retro look but with undeniable contemporary quality.

Sonic Saver hoops equip the shells to give that perfect balance between triple flanged and die cast tone whilst the bass drum is finished beautifully with matching Walnut rings.

For the ultimate vintage tone, the toms are fitted with Remo Ambassador Suede Batter heads to give that bright attack and warmth, whilst the kick is adorned with a P3 Suede batter head and a striking antique BP logo display head.

This kit is available in one configuration only, 22x16, 12x8 and 16x16 (S1000 snare stand included for tom mounting).

Only 100 kits produced worldwide, we have 30 coming to the UK so don't hang around, find these timeless sets while you can!



KIT SPECIFICATIONS

- 8.1mm Pure Walnut shells
- 1:9 bearing edges
- Isolated Mounting System
- Floating Spring Loaded Floor Tom Legs
- Single-Point-of-Contact Lugs
- 2.3mm Sonic Saver Hoops
- Remo Ambassador Suede Batter Drumheads
- Remo P3 Suede Batter Bass Drumheads
- S1000 snare stand included



SATURN

UNTIL YOU ACTUALLY SIT BEHIND A SATURN KIT AND HEAR FOR YOURSELF WHAT TWO THIN WALNUT PLYS DO FOR ULTRA-THIN MAPLE SHELLS, YOU REALLY DON'T KNOW WHAT YOU'RE MISSING. THE BASS DRUM HAS THAT EXTRA-FAT BOTTOM END, THE FLOOR TOMS THAT UNMISTAKABLE PUNCH, THE MOUNTED TOMS RING WITH WARM RESONANCE LIKE YOU'VE NEVER HEARD.

The perfect drum set for the road warrior, the Saturn is everything you need to make an impact on stage. Lightweight hardware, finishes especially designed to make the most of stage lighting, and above all, sonic qualities that set you apart from everyone else.

Sit down behind a Saturn and discover what so many touring professionals have learned.

Do it for the crowd. Do it for the band. Do it for yourself. The Mapex Saturn may just be the last drum set you'll ever buy.



JASON BOWLD AXEWOUND

CONFIGURATIONS

SW504

- 20x18 Undrilled Bass Drum
- 10x8 Rack Tom
- 12x9 Rack Tom
- 14x14 Floor Tom

Includes: TH684S x 2, AC910 x 2

Colours: IL, OW, TT

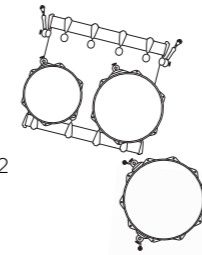

SW524

- 22x18 Undrilled Bass Drum
- 10x8 Rack Tom
- 12x9 Rack Tom
- 14x14 Floor Tom

Includes: TH684S x 2, AC910 x 2

Colours: IL, OW, TT, WT, RL

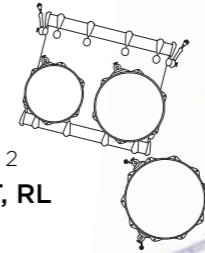

SW529

- 22x20 Undrilled Bass Drum
- 10x7 Rack Tom
- 12x8 Rack Tom
- 16x14 Floor Tom

Includes: TH684S x 2, AC910 x 2

Colours: IL, OW, TT, WT, RL

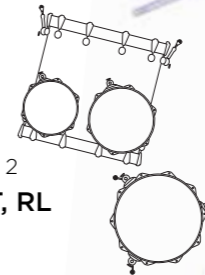

"Mapex have produced a serious kit here, in both terms of quality and price. Whether for live work or in the studio you will have a fantastic sounding and looking set of drums made with attention to detail and craftsmanship. They look and feel very classy. If you are in the market for a kit right now, I would definitely check out the Saturn series."

MIKE DOLBEAR.COM

SW509

- 20x20 Undrilled Bass Drum
- 10x7 Rack Tom
- 12x8 Rack Tom
- 16x14 Floor Tom

Includes: TH684S x 2, AC910 x 2

Colours: IL, OW, TT, WT, RL

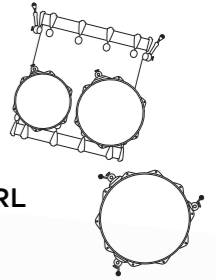

KIT SPECIFICATIONS

- 6-ply, 5.1mm all North American maple (4-ply) and walnut (2-ply) shell construction
- Eight coat, high-gloss, hand-rubbed lacquer finish
- All maple matching lacquered bass drums hoops
- Low mass, single-point-contact lugs
- I.T.S off-the-shell, isolated tom mount system
- 2.3mm rigid steel Mapex Powerhoops
- Isolated double tom holder
- Non-penetrating bass drum spurs
- Remo Weatherking Emperor drum heads

FINISHES



WT Transparent Walnut



IL Sterling Sparkle



RL Cherry Sparkle

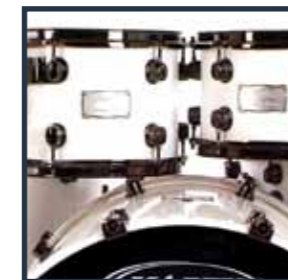

OW Arctic White



TT Blue Galaxy Fade

JAZZ CAFE
LONDON
WWW.JAZZCAFE.CO.UK

MERIDIAN Maple

MERIDIAN MAPLE USHERS IN A NEW LEVEL OF QUALITY AND FUNCTIONALITY IN MID-LEVEL, ALL MAPLE DRUM SETS. WITH A COMPLETELY NEW LUG AND REDESIGNED LIGHTWEIGHT ISOLATED TOM MOUNTING SYSTEM, THE MERIDIAN SERIES FEATURES BRIGHT AND RESONANT ALL MAPLE SHELLS IN A WIDE SELECTION OF LACQUERED AND COVERED FINISHES.

Mapex's newly designed Isolated Tom Mount System is significantly lighter in weight and lower in profile than before and is more easily mounted and adjusted. The 7ply All-Maple shells resonate freely with minimal contact from hardware components.

Each Meridian Maple set is proudly finished with an eight coat, high gloss, hand-rubbed lacquer that's more often only kept exclusively for custom, high end sets.

PAiSte
MADE IN SWITZERLAND

CONFIGURATIONS

MP481SJ

- 18X14 Bass Drum
- 12x8 Rack Tom
- 14x14 Floor Tom
- 14x5.5 Snare

Includes: TH654, AC909 Rizer

Colours: RR

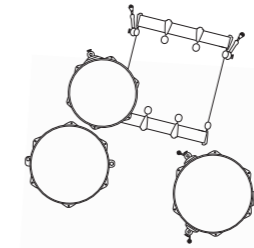

MP529SFK2JB

- 22x20 Undrilled Bass Drum
- 10x7 Rack Tom
- 12x8 Rack Tom
- 16x14 Floor Tom
- 14x5.5 Snare

Includes: TH676 x 2, AC910 x 2

Colours: GA, OW-B, SV

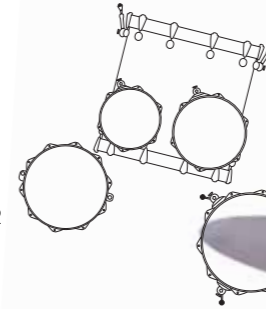

MP529SFK

- 22x16 Retro Bass Drum
- 10x7 Rack Tom
- 12x8 Rack Tom
- 16x14 Floor Tom
- 14x5.5 Snare

Includes: TH676 tom holder

Colours: OW-C

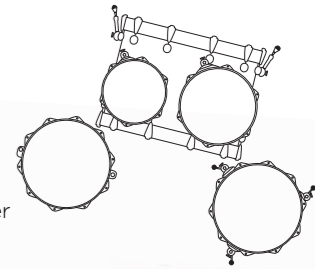

"The 'Jazz' set-up certainly impressed us, with a wealth of tone and musicality, not forgetting enough muscle to cover more than just 'jazz' dates. Each drum rang true and tuning options are not just limited to jazz, though this is where the drums work best as they sing even under the lightest of touches."

IDRUM MAGAZINE



KIT SPECIFICATIONS

- 7-ply all Maple, 5.8mm toms and snares, 7.2mm bass drum
- Newly engineered Isolated Tom Mount System (ITS)
- Newly designed lug with smaller footprint for lower overall mass
- 2.3mm Mapex Powerhoops
- Spring-cushioned floor tom legs
- Eight coat, high-gloss, hand-rubbed lacquer finish
- Redesigned bass drum tom mount with built-in adapter for optional boom arm
- Low-profile, recessed bass drum claws with cushioning gasket
- Remo® ut pinstripe heads

FINISHES



GA Galaxy Fade w/ Black Hardware



RR Chesnut Burst w/ Chrome hardware



OW-C Arctic White w/ Chrome hardware



OW-B Arctic White w/ Black Hardware



SV Supernova Fade w/ Black Hardware



MERIDIAN Birch

LIKE ITS MAPLE COUNTERPART, THE MERIDIAN BIRCH EMPLOYS THE SAME LIGHTWEIGHT AND ERGONOMIC ISOLATED TOM MOUNTING SYSTEM FOR MAXIMUM RESONANCE AND SUSTAIN. THE MERIDIAN'S THIN BIRCH SHELLS OFFER PLENTY OF ATTACK AND REMARKABLY BRIGHT TONE. THE RESULT IS ASTOUNDING PROJECTION AND CUTTING POWER.

Additionally, the unique Mapex off-the-shell design and single-point-of-contact lugs distribute tension evenly across the shell for even better resonance and sustain.

As these drums know they are in for some serious action, all Meridian Birch sets come with all-new, feature-rich Mapex 700 Series hardware.



CONFIGURATIONS

MR5045

- 20x18 Bass Drum
- 10x8 Rack Tom
- 12x9 Rack Tom
- 14x14 Floor Tom
- 14x5.5 Snare

Includes: 700 series H/W set (no throne)

Colours: BD, LE, SI, WA, MB, UA

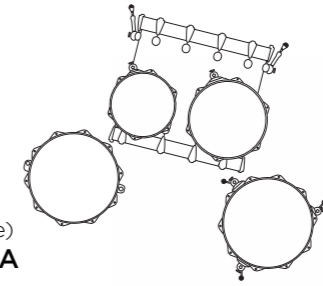

MR5245

- 22x18 Bass Drum
- 10x8 Rack Tom
- 12x9 Rack Tom
- 14x14 Floor Tom
- 14x5.5 Snare

Includes: 700 series H/W set (no throne)

Colours: BD, LE, SI, WA, MB, UA

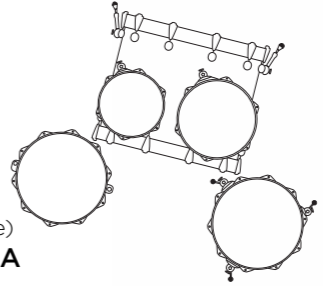

MR5295FK2

- 22x20 Bass Drum Undrilled Bass Drum
- 10x7 Rack Tom
- 12x8 Rack Tom
- 16x14 Floor Tom
- 14x5.5 Snare

Includes: 700 series H/W set (no throne) plus TH684S x 2, AC910 x 2

Colours: BD, LE, SI, WA, MB, UA

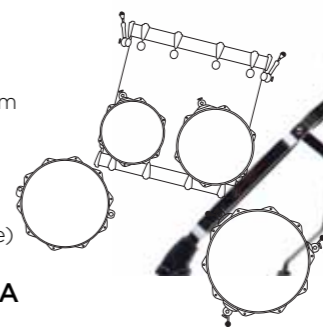

"This is a great kit and it feels really nice to play, and the floor toms and bass drum have loads of tone and bottom end. Birch has a slightly different feeling and response to maple which is worth bearing in mind if you check out this kit and are normally a maple player. For some having a birch kit is a must in the tool box as an alternative to a maple, to others its the only way to go."

MIKE DOLBEAR.COM

FINISHES



BD Black Forest Fade

KIT SPECIFICATIONS

- 6-ply all birch, 7.2mm toms and snares, 7.2mm bass drum
- Newly engineered Isolated Tom Mount System (ITS)
- Newly designed lug with smaller footprint for lower overall mass
- Eight coat, hand-sanded, high gloss lacquer finish
- Redesigned bass drum tom mount with built-in adapter for optional boom arm
- Low-profile, recessed bass drum claws with cushioning gasket
- All birch snare drum
- Remo® UT heads



LE Cherry Mist

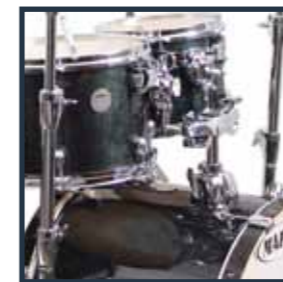

MB Midnight Black



SI Sapphire Fade



UA Umber Fade



WA Walnut Fade

FORGE
1635

12 BAR
CLUB



HORIZON Birch

THE MAPEX HORIZON BIRCH SERIES HAS CUTTING EDGE FEATURES AND SOUND QUALITY THAT GO UNRIVALLED AT ITS PRICE POINT. THE BIRCH AND POPLAR SHELLS DELIVER RICH, CONTROLLED SOUND AND PROJECTED TONE IN ANY VENUE.

The Horizon HZB Series comes complete with exclusive Isolated Tom Mounting System (ITS) and low-profile die-cast cushioned bass drum claw hooks. HZB 5-shell sets are also supplied with 3-stage boom stands as standard.

Horizon HZB Kits come in two inspiring configurations and an array of high gloss lacquer finishes. Add-on components are also available, meaning there's nothing stopping you from building the kit of your dreams.



CONFIGURATIONS

HZB4835K

- 18x16 Bass Drum
- 12x8 Rack Tom
- 14x14 Floor Tom
- 14x5.5 Snare

Includes: 500 series H/W set (no throne)

Colours: RY, WA

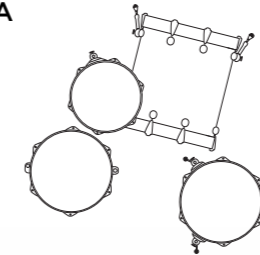

HZB5295FJ

- 22x18 Undrilled Bass Drum
- 10x7 Rack Tom
- 12x8 Rack Tom
- 16x14 Floor Tom
- 14x5.5 Hammered Steel Snare

Includes: 531 series H/W set (no throne)

Colours: SI, MB, WT, CY

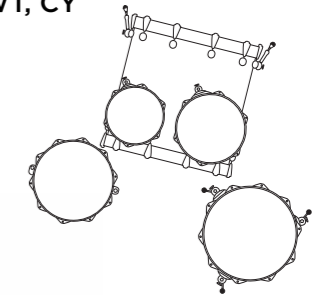

BEST BUDGET KIT IN THE WORLD TODAY
 "Raising the standard of what to expect from a starter kit, the Mapex Horizon comes in choice hybrid Poplar shells with stained and lacquered outer Birch laminate"
MUSICRADAR.COM

KIT SPECIFICATIONS

- 7.2mm, 6ply, Birch/Poplar Bass Drum, Tom & Snare Shells
- High Gloss, Lacquer Finishes
- Chrome Hardware or Black Coated Hardware
- 14" x 5.5" Hammered Steel MPX Snare Drum with 5295 set
- Isolated Mounting System
- Single-Point-of-Contact Lugs
- 1.5mm Steel Flanged Hoops
- Instructional Setup DVD Included
- Remo UX Drumheads

FINISHES



RY Rattan Yellow



CY Transparent Cherry



MB Midnight Black



SI Sapphire Fade



WT Transparent Walnut

HORIZON

HORIZON HX IS THE PERFECT CHOICE FOR THE SERIOUS BEGINNER OR THE IDEAL SECOND SET FOR THE PLAYER ON THE GO. THE POPLAR SHELL AND THE NEWLY REDESIGNED ISOLATED TOM SYSTEM (I.T.S.) ENSURE THAT HORIZON DELIVERS FULL RICH TONE AND REMARKABLE SUSTAIN.

Horizon is available in two popular configurations and a three durable and attractive covered finishes. Every Horizon Series drum set comes with a full set of all-new 531 Series Mapex Hardware, featuring multi-sustain cymbals felts, newly designed ergonomic memory locks and double braced legs.

A Mapex branded 3PCE CYMBAL SET is included with each and every kit to get you started as soon as that box is opened!



CONFIGURATIONS

HX5045TCZJ

- 20x18 Bass Drum
- 10x8 Rack Tom
- 12x9 Rack Tom
- 14x14 Floor Tom
- 14x5.5 Snare

Includes: 531 series H/W set & 3pce Cymbal set

Colours: **CK, NS, QS**

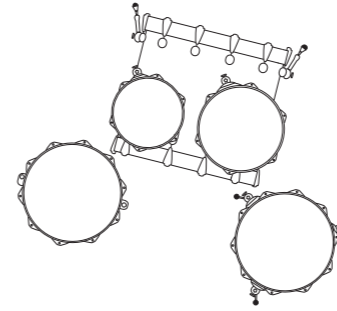

HX5295TCZJ

- 22x18 Bass Drum
- 10x8 Rack Tom
- 12x9 Rack Tom
- 16x16 Floor Tom
- 14x5.5 Snare

Includes: 531 series H/W set & 3pce Cymbal set

Colours: **CK, NS, QS**

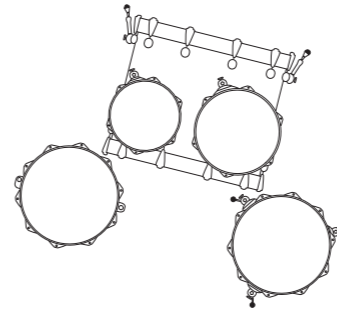

“As a first gigging kit the Horizon sounds big and will suit any style. The Horizon HX package offers a lot for the money and its looks belie its budget status.”
MUSICRADAR.COM

KIT SPECIFICATIONS

- 7.2mm Poplar shell with new durable high-gloss wrapped new finishes
- New double tom holder with auxiliary cymbal placement position
- Re-engineered Isolated Tom Mount System (ITS)
- New tom bracket for quick set up and tear down
- Low-profile cushioned bass drum claws
- 500 series hardware
- Memory locks for extra security on 500 series hardware
- Multi-sustain cymbal felts on 500 series hardware
- Retractable Boom arm
- REMO® drum heads and self muffling bass drum head

FINISHES



QS Grey Sparkle



CK Silver Sparkle



NS Blue Sparkle

VOYAGER

THE ALL-NEW MAPEX VOYAGER DELIVERS GREAT SOUND AND STUNNINGLY COOL LOOKS RIGHT OUT OF THE BOX!

The Voyager's Poplar shells are available in striking new Black and White covered finishes and feature newly designed lugs, tom mounts and a double tom holder that accommodates an auxiliary cymbal placement.

The Voyager comes with compact and durable Mapex 330 Series double braced hardware, two piece Mapex cymbal set and a cushioned drummer's throne, everything to get you started playing the day you get it home.

Start your journey into drumming in the right direction with Mapex Voyager.

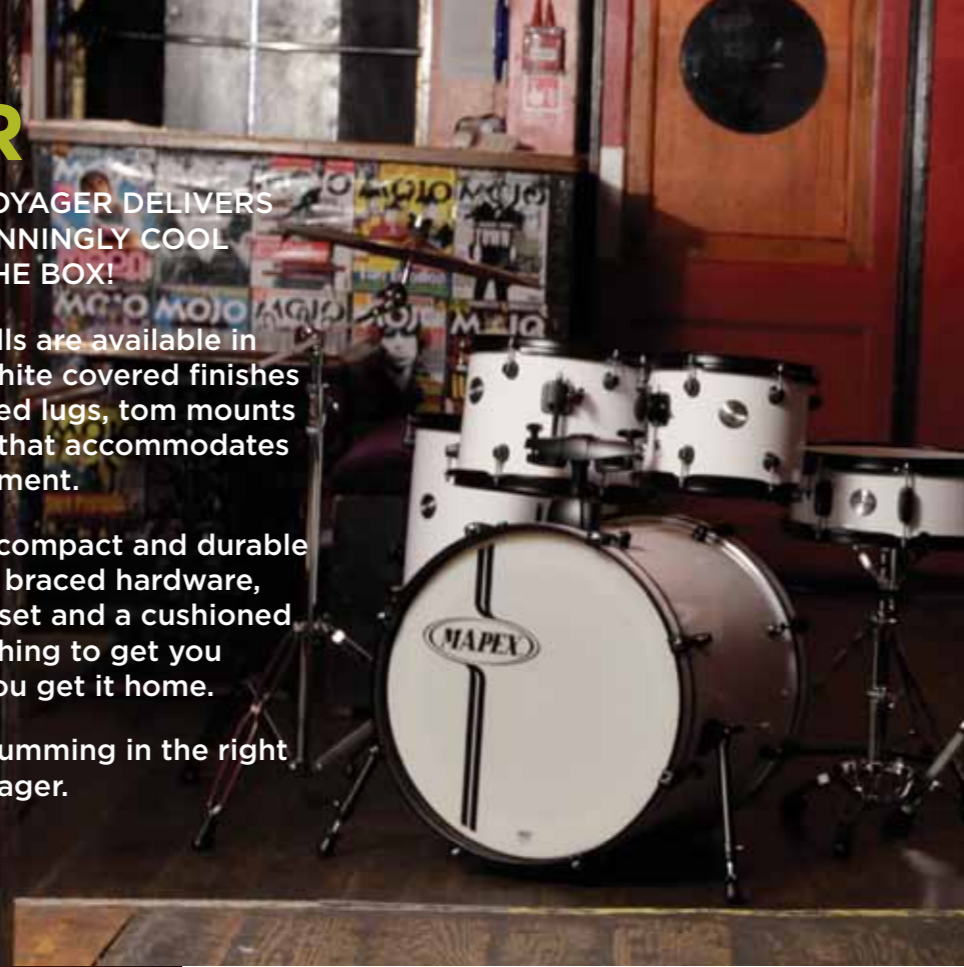

CONFIGURATIONS

VR5044TCZB

- 20x16 Bass Drum
- 10x8 Rack Tom
- 12x9 Rack Tom
- 14x14 Floor Tom
- 14x5.5 Snare

Includes: H/W set & 2pce Cymbal set

Colours: DK, SW

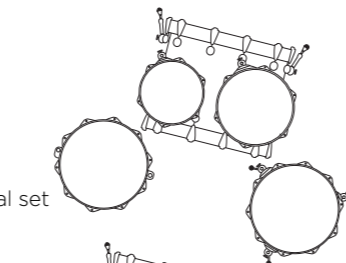

VR5294TCZB

- 22x16 Bass Drum
- 10x8 Rack Tom
- 12x9 Rack Tom
- 16x16 Floor Tom
- 14x5.5 Snare

Includes: H/W set & 2pce Cymbal set

Colours: DK, SW

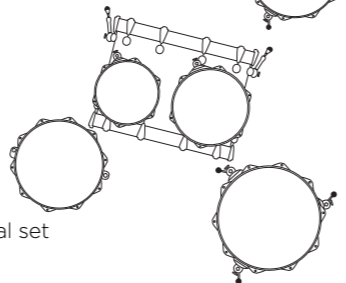

FINISHES



DK Black w/ Black fittings



SW White w/ Black fittings

TORNADO

Tornado kits are manufactured exclusively in our own wholly owned drum production facility, and built to a level of quality only our state of the art machinery, highly trained staff and expert production techniques can guarantee. Our drum factory is one of the only facilities of its kind in the world to have achieved ISO9001 certification, the worlds standard for manufacturing excellence.

Tornado drum shells are made from hand selected basswood ply's and all kits feature ball and socket tom holders for ultimate positioning and double braced hardware throughout.

All Tornado kits also include a matching wood shell snare drum and are shipped with Hi Hat and Crash/ Ride.

Tornado is supplied in durable, high quality Black and Burgundy wrap finishes.

FINISHES



DK Black

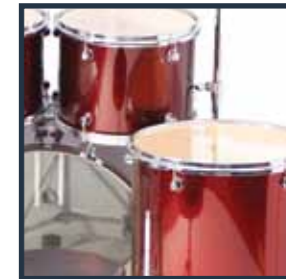

DR Burgundy

CONFIGURATIONS

TNM5044TCU

- 20x16 Bass Drum
- 10x8 Rack Tom
- 12x9 Rack Tom
- 14x14 Floor Tom
- 14x5.5 Snare

Includes: H/W set & 2pce Cymbal set

Colours: DK, DR

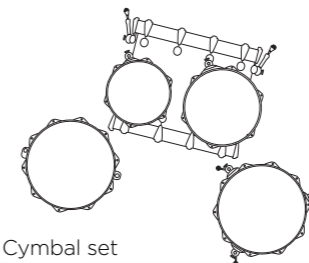

TNM5294TCU

- 22x16 Bass Drum
- 10x8 Rack Tom
- 12x9 Rack Tom
- 16x16 Floor Tom
- 14x5.5 Snare

Includes: H/W set & 2pce Cymbal set

Colours: DK, DR

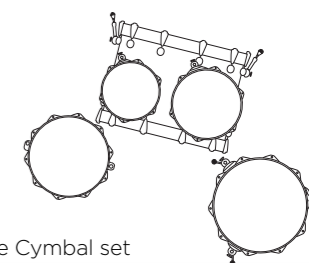

BLACK PANTHER SNARES

the **STINGER**

1mm steel shell
10" x 5½"
traditional 45° bearing edge
Tune this drum high and hit it hard. It'll only hurt for a second.
BPST0551CN



the **SLEDGEHAMMER**

1.2mm hammered brass shell
14" x 6½"
traditional 45° bearing edge
Some jobs call for heavy duty equipment. This drum bludgeons its way through the din with extreme volume and a distinct rounded tone.
BPBR465HZN



the **PANTHER**

3mm solid steel seamless shell
2mm seamless steel c&c formed shell
1mm seamless steel c&c formed sound control ring
14" x 5"
6:4 bearing edge
The ultimate Black Panther Snare Drum features a sensitive feel, big volume and a warmer sound than you would ever expect from a metal drum.
BPST450SLN



the **BLADE**

1mm steel shell
14" x 5½"
traditional 45° bearing edge
A visually sleek and alluring instrument with razor-sharp tone that carves deeply into any groove.
BPST4551LN



the **MACHETE**

1mm steel shell
14" x 6½"
traditional 45° bearing edge
If you're in need of a drum that can hack its way through the thickest of guitar noise, look no further.
BPST4651LN



the **BRASS CAT**

1.2mm brass shell
14" x 5½"
traditional 45° bearing edge
Slightly softer than a steel snare.
This drum produces an aggressive sound that's incredibly smooth.
BPBR4551ZN



the **PHANTOM**

5.1mm shell constructed from two exterior 1.7mm birch plies and one interior 1.7mm walnut ply
12" x 5"
5:5 bearing edge
This drum, with its unique hybrid shell possesses incredible sensitivity that makes ghost notes sing.
BPBW2500CNWA



the **VELVETONE**

8.1mm shell constructed from one 3mm exterior burl maple ply, one 3.4mm walnut middle ply and one 1.7mm interior maple ply
14" x 5½"
1:9 bearing edge
Don't be deceived by its beautifully seductive exterior, this drum is wickedly dark with a high degree of sensitivity.
BPMW4550CNUB



the **CHERRY BOMB**

12mm maple shell
13" x 5½"
1:9 bearing edge
Classic in style and performance, this uniquely sized drum is as distinctive to the ear as it is to the eye.
BPCW3550CNCY



the **BLACK WIDOW**

5.1mm maple shell
14" x 5"
5:5 bearing edge
This full-bodied, versatile drum features extreme sensitivity and a dark, dry tone.
BPML4500LNTB



the **PHATBOB**

12mm maple shell
14" x 7"
2:8 bearing edge
Built to be played hard and loud, this bad boy features an extra thick shell, rounded bearing edge and a deep snare bed for a thick, fat sound.
BPML4700TLNTB



the **RETROSONIC**

8.1mm walnut shell
14" x 5½"
1:9 bearing edge
This classically styled, beautifully crafted drum produces a rich, vintage-style sound.
BPWB4550CNEN



the **FASTBACK**

5.1mm maple shell
12" x 7"
1:9 bearing edge
The size and tuning range of this drum combine to produce a distinctive high pitch with plenty of body making it a great choice for Gospel or R&B.
BPML2700CNIT



the **BLASTER**

8.4mm shell constructed from 5.1mm maple shell and 3.4mm walnut reinforcing rings
13" x 7"
5:5 bearing edge
A simply ear-shatteringly loud and aggressive drum.
BPML3700LNWA



BLACK

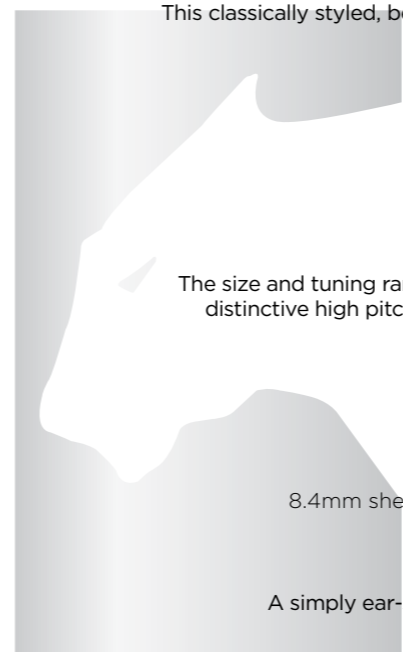

PANTHER

MPX SNARES

THE **MAPEX MPX SNARE** LINE OFFERS HIGH PERFORMANCE SNARES AT AGGRESSIVE PRICES. MPX SNARES WERE INTRODUCED TO COMPLEMENT THE MAPEX BLACK PANTHER SERIES OF PREMIUM SNARE DRUMS, EACH ADDRESSING THE NEEDS OF TODAY'S PERFORMING DRUMMER.

MPX STEEL

- 1.0mm steel shell
- Chrome finish
- Low-mass lugs
- Chrome hardware
- Fully adjustable throw-off
- Remo® UX drum heads



10 x 5.5
[MPST0554]



13 x 3.5
[MPST3354]



14 x 5.5
[MPST4560]



13 x 6
[MPML3600BMB]



14 x 5.5
[MPML4550BMB]

MPX BLACK MAPLE

- 6.5mm maple shell
- Transparent Black Lacquer
- Low-mass lugs
- Chrome hardware
- Fully adjustable throw-off
- Remo® UX drum heads

MPX MAPLE

- 6.5mm maple shell
- Gloss natural
- Low-mass lugs
- Chrome hardware
- Fully adjustable throw-off
- Remo® UX drum heads



13 x 6
[MPML3600CNL]



14 x 5.5
[MPML4550CNL]



14 x 7
[MPML4700CNL]



P1000 FALCON SINGLE

- Double chain drive
- Solid steel base plate
- Reversible Beater Head
- 10g & 20g beater weights



P1000TW FALCON DOUBLE

- Double chain drive
- Solid steel base plate
- Reversible Beater Head
- 10g & 20g beater weights
- Also available as left footed



P900D RAPTOR SINGLE

- Direct drive
- Torque free spring system
- Reversible Beater Head
- 10g fitted beater weights



P900DTW RAPTOR DOUBLE

- Direct drive
- Torque free spring system
- Reversible Beater Head
- 10g fitted beater weights
- Also available as left footed



P710 SINGLE PEDAL

- Direct drive
- Torque free spring system
- Reversible Beater Head
- 10g fitted beater weights



P710TW DOUBLE PEDAL

- Direct drive
- Torque free spring system
- Reversible Beater Head
- 10g fitted beater weights
- Also available as left footed



P500 SINGLE PEDAL

- Single chain drive
- Fully Adjustable Spring Tension
- Duo-tone felt/ABS beater
- Compact stabilizer radius rods
- Retractable Floor Spikes



P500TW DOUBLE PEDAL

- Single chain drive
- Fully Adjustable Spring Tension
- Duo-tone felt/ABS beater
- Fully independent universal linkage adjustment
- Compact stabilizer radius rods
- Retractable Floor Spikes

PEDALS

BOOMS



B330 **BOOM STAND**
2 Stage Boom Stand



B500 **BOOM STAND**
Horizon series
2 Stage Boom Stand



B700 **BOOM STAND**
Meridian Series
3 Stage Boom with
stepless tilter



B710 **BOOM STAND**
Meridian Series
700 series counter weight
boom



B1000 **BOOM STAND**
3 Stage boom with
stepless tilter, lockable
quick release cymbal nut

SNARE STANDS



S500 **SNARE STAND**
• Multi-tooth ratchet snare
basket tilter



S700 **SNARE STAND**
• Multi-tooth ratchet snare
basket tilter



S750A **SNARE STAND**
• Universal Ball-in-Socket
Snare Basket Tilter



S1000 **SNARE STAND**
• Ground Reaching Center
Shaft positioning
• Universal Ball-in-Socket
Basket w/ handle Tilter



T250A **THRONE**
• Round Seat
• Slotted Base



T570A **THRONE**
• Padded Round
Seat
• Memory Locked
Base



T575A **THRONE**
• Motorcycle Seat
• Memory Locked
Base



T750A **THRONE**
• Padded Round Seat
• Threaded Base



T755A **THRONE**
• Motorcycle Seat
• Threaded Base



T760A **THRONE**
• Black round cloth seat
• Threaded Base



T765A **THRONE**
• Black cloth motorcycle
seat
• Threaded Base



T765R **THRONE**
• Red cloth motorcycle
seat
• Threaded Base



H500 **HI HAT STAND**
• Multi-sustain cymbal felts
with slip-proof nylon inner
sleeve
• Chain-Pull drive system
• Double braced legs
• Newly designed pedal
platform



H700 **HI HAT STAND**
• New multi-sustain cymbal
felts
• Tru-direct-pull™ drive system
• Adjustable angle footboard
• 10-stop wide-range
tension adjustment
• 360° Rotating Leg Assembly
• Double Braced Legs



H750A **HI HAT STAND**
• Tru-Direct Pull™ Drive
System
• Adjustable Angle Foot-
board
• 10-Stop Wide-Range
Tension Adjustment with
Gauge
• Heavy Felt Cymbal Seat
• OS Cymbal Accentuator
for Top Cymbal
• 360° Rotating Leg
Assembly
• Double Braced Legs



T770 **THRONE**
• Round top with backrest
• Four Leg, threaded Base



T775 **THRONE**
• Saddle top with backrest
• Four leg Threaded Base

HI HAT STANDS

THRONES



101 SERIES BRASS UNIVERSAL SET
SOUND - Overall - musical, harmonic, powerful

Set consists of - 14" Hi Hats, 16" Crash, 20" Ride

PST3 UNIVERSAL SET

SOUND - Bright, clean, powerful with fundamental functional and musical characteristics

Set consists of - 14" Hi Hats, 16" Crash, 20" Ride PLUS **FREE 10" Splash for XMAS 2012**

PST5 UNIVERSAL OR ROCK SET

SOUND - Bright, clean, full, focused, cutting and energetic with full functional and musical characteristics

Universal set supplied with 'Medium' models, Rock set with heavier 'Rock' models

Sets consist of - 14" Hi Hats, 16" Crash, 20" Ride PLUS **FREE 14" China for XMAS 2012**

PST8 UNIVERSAL SET

SOUND - Bright, clean, full, focused, cutting and energetic with clarity, warmth, and tonal definition

Set consists of - 14" Hi Hats, 16" Crash, 20" Ride



ALPHA BOOMER (Nico McBrain) SET
SOUND - Bright, crisp, energetic, powerful, and cutting with clarity, warmth, and tonal definition

Set consists of:
FREE 12" Metal Splash, 14" Hi Hats, 18" Crash, 22" Ride

ALPHA HYPER (Joey Jordison) SET
SOUND - Bright, piercing, metallic, energetic, powerful and aggressive with clarity and cutting definition

Set consists of:
FREE 10" Metal Splash, 14" Hi Hats, 16" Crash, 20" Ride



PRACTICE

ROCK MUTE SET

12", 13", 14", 16", 22" plus Hi Hat and two cymbal mutes

22" FUSION SET

10", 12", 14" x 2, 22" plus Hi Hat and two cymbal mutes

20" FUSION SET

10", 12", 14" x 2, 20" plus Hi Hat and two cymbal mutes

ROCK/FUSION SET

10", 12", 14", 16", 22" plus Hi Hat and two cymbal mutes



SINGLE SIDED PAD

Available in 6" & 12" versions



DOUBLE SIDED PAD

Available in 6" & 12" versions



SINGLE SIDE DIVIDED PAD

12" double surface



ESSENTIALS STICK BAG

Cleverly designed to hold 4-5 implements.



STICK BAG

Holds 24 pairs of sticks and mallets and contains two small accessory pockets. Four outside pockets include one large enough for sheet music.

STANDARD STICK BAG

Three inside pockets hold 12 pairs of sticks with an outside pocket for small accessories.



ACCESSORIES

STICK BAG - SKULLS

Designed with real personality, these new bags are available in digital camo and skull & crossbone patterns. Able to hold 24 pairs of sticks, these high end bags also have plenty of pockets for accessories and sheet music.



THE **KICKPORT**® PATENTED DESIGN ENHANCES THE SOUND OF YOUR KICK DRUM BY DOING FOUR THINGS:



- It ports the kick drum in the same manner as a bass reflex speaker cabinet which boosts low frequencies.
- It adds ideal dampening directly to the resonant head which allows you to remove most if not all of the internal materials thus reclaiming all of the natural resonance and tone of your drum.



- It focuses the air as it exits the kick drum and this compression increases punch.

- It's tunable! Due to its broadband design, The KickPort® improves the sound of bass drums sized 16" to 28." It can be tuned up or down by adjusting the tuning of the resonant head.



KICKPORT BLACK
Bass drum soundport in Black

KICKPORT WHITE
Bass drum soundport in White

KICKPORT CHROME
Bass drum soundport in Chrome

KICKPORT GOLD
Bass drum soundport in Gold



THE OVERALL RESULT IS MORE LOWS, MORE TONE, BETTER DEFINITION AND MORE PUNCH IN VARYING ACOUSTIC ENVIRONMENTS. ADDITIONALLY THESE ARE BENEFITS THE DRUMMER CAN FEEL BEHIND THE KIT.

CP1 BLACK
Cajon Soundport in Black



TRG BLACK
Bass drum reinforcing O-ring **Black**

TRG WHITE
Bass drum reinforcing O-ring **White**

DPD BLACK
Bass drum impact pad (2 Pack) **Black**

DPD WHITE
Bass drum impact pad (2 Pack) **White**



*"And so faintly you came tapping, tapping at my chamber door,
That I scarce was sure I heard you, here I opened wide the door;
Darkness there, and nothing more."*

*-Poe-
The Raven*



Meridian Black - The Raven

LANDING SUMMER 2012



Printed and distributed by KORG UK Ltd
www.mapex.co.uk
www.facebook.com/mapexuk
[@mapexdrums](https://www.instagram.com/mapexdrums)

