

PAiSte
GONGS & SOUNDS

History.....	Page 3
Our Story.....	Page 3
Advice regarding the Handling of Gongs (The Anatomy of the Gong, Gong Striking Areas, The Sound of the Gong with Respect to the Mallet, Suspension of Gongs, Transport and Handling of Gongs, Care of Gongs).....	Page 4/5
Inscription of the Gongs.....	Page 5
Designation of Sizes.....	Page 5
Designation of Pitches.....	Page 5
Paiste Gong Production.....	Page 6
Planet Gongs (PG).....	Page 7
Symphonic Gongs (SG).....	Page 8/9
Sound Creation Gongs (SCG).....	Page 10/11
Tuned Gongs (TG).....	Page 12/13
Tuned Percussion.....	Page 12/13
Crotales.....	Page 12
Tuned Discs.....	Page 13
Paiste Sound Production.....	Page 14
Sound Plates.....	Page 15
Rotosound.....	Page 15
Cup Chimes.....	Page 15
Sound Discs.....	Page 15
Accent Gongs.....	Page 16
Finger Cymbals.....	Page 16
Percussion Cymbals "Extra Thin".....	Page 16
Accent Cymbals.....	Page 16
Multisound Holder – Combination Possibilities.....	Page 17
Percussion Set.....	Page 17
Gong Stands.....	Page 18
Gong Stand Drawings and Individual Parts.....	Page 19-22
Sound Stand Drawings and Individual Parts.....	Page 23-25
Gong Mallets.....	Page 26
Sound Mallets.....	Page 26
Deco Gongs.....	Page 27
Gong Cases.....	Page 27
Sound Cases.....	Page 27

Presented by:

Paiste GmbH & Co. KG, Gorch-Fock-Strasse 13,
D-2373 Schacht-Audorf, Germany
Paiste AG, Hauptstrasse, CH-6207 Nottwil, Switzerland
Paiste America, Inc., 460 Atlas Street, Brea CA 92621/USA

Gongs belong to the oldest and most important musical instruments of South East Asia. Their origins may be traced back to the second millennium B.C., but it is assumed that the gong is much older. In Chinese history gongs are mentioned around 500 A.D., attributed to a nation called HSI YU between Tibet and Burma during the reign of Emperor Hsuan Wu.

Historic research provides us with four main centers - Burma, China, Annam, Java – at least 7 gong shapes and sound structures stem from these regions. Only few families knew the tradition of gong making as it was passed from generation to generation. The art of making gongs was veiled in a sense of magic. Gong makers then believed that a gong could only succeed with the help of higher powers and, that they were exposed to such forces more so than ordinary humans.

The gong was an important element in the lives of Far East people and it still is in some countries today. In Asian families the gong was an attribute of wealth and served as a status symbol. In rites the gong was used in the evocation of ghosts and in the banning of demons. Touching a gong brought you fortune and strength. In the rituals of the Far East the gong has retained its special significance to this day.

As a musical instrument the gong accompanied celebrations and funeral ceremonies, songs and theatre plays. In the music of the Asian high cultures the gong was used as an orchestral instrument. Orchestras with gong plays containing up to 18 notes were not seldom. They were also played in private concerts at residences. In the following you will find some examples of scales and gong melodies:

Scales:

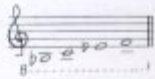

4 tone scale:
Gamelan tjarabalen,
Java

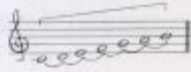

7 tone scale:
Burma, Siam

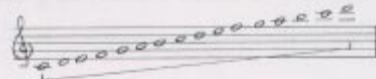

16 tone scale:
Khang Tok, Cambodia;
Kong Yai, Siam

Gong Melodies:

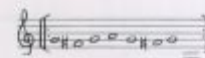

Funeral melody
of the Dajak

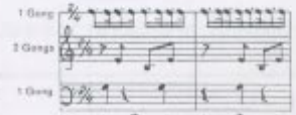

Gong piece from Lekebai,
Middle East Flores, Indonesia

Since about 1790, gongs were used in European orchestras. Since then the terms "Tam Tam" for flat gongs, and "Gong" for bossed gongs have become customary. However, the authentic term in all languages of the origin countries is GONG.

Our Story

Creating gongs is a dedication to the deeper meaning of the structured, focused vibrations which unfold into sound upon playing the gong and thus have an effect on human beings.

Not only do you hear the gong sound but you also feel its vibrations on and inside your body. The resulting feelings reach into the depths of your psyche. When you add the visual aspect, the trembling shape of the gong, and the physical contact to the gong by the mallet or the bare hand, dimensions of impressions ensue which can be experienced by anyone. These impressions can be discovered and experienced ever anew by composers and musicians and then conveyed to the listener; and, they are communicated to the individual who interacts with the gong personally.

The gong maker begins with a round disc of bronze alloy containing a sound potency which is as of yet still resting within itself; it can then be shaped into frequency ranges and expressions of sound. The tools are fire, steel, hammer, and anvil. The gong maker has an intensive intuitive conception of the sound (highs – lows – character – color – expression – impression); a goal therefore, an intent to fulfill this conception. The outer appearance of the gong is a result of the kind of work necessary to achieve the particular sound expression aimed for.

Each hammer blow is etched irretrievably into the metal and shapes the sound until its completion with the last four or five well placed blows. Three hammer blows could be too little to achieve the goal, while the sixth may overshoot it for ever. This decision rests with the gong maker for each individual gong. He achieves his craft and experience through years of striving, guided by the master and counseled by the elder master. This process has been backed by our company's philosophy for almost a century, and we continue to cultivate the age old tradition of gong making at the verge of our transition into the 21st century.

The Anatomy of the Gong

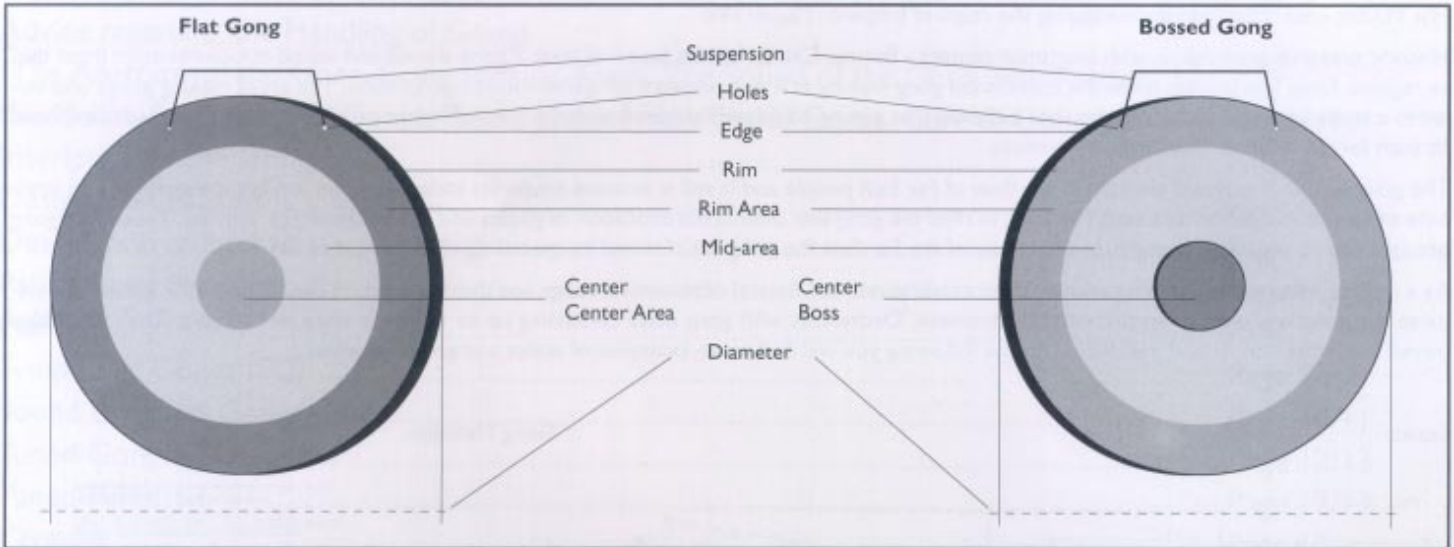

Gong Striking Areas

Depending on where the gong is struck, it reacts differently with respect to sound.

The following principle applies:

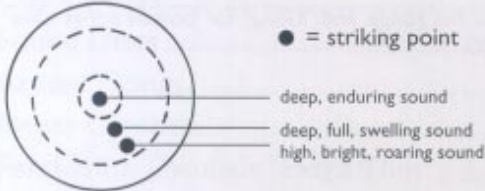

Each gong, whether Symphonic Gong, Sound Creation Gong, Planet Gong, or Tuned Gong, has an ideal striking point at which its sound unfolds optimally according to its character and sound quality. In this brochure the ideal striking points and the corresponding sound visualizations are marked and listed as follows:

● = the ideal striking point corresponding to the particular gong

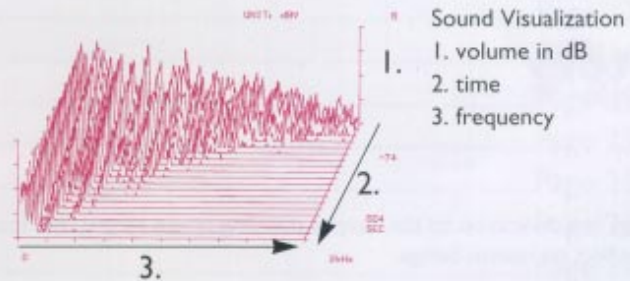

The Sound of the Gong with Respect to the Mallet

The sound and reaction of the gong are determined by the size, weight and the material the mallet is made of. The mallets listed in the table on page 26 are in accordance with the proper requirements. If you will use other mallets or tools, please make sure that the materials used are not too hard or sharp in order to avoid damaging or detuning the gong. However, it is quite possible you may be able to create interesting and fascinating sounds through the use of various materials and objects while utilizing appropriate care.

Suspension of Gongs

Each Paiste Gong comes with suspension made of gut string. Gut string is supremely suited as it minimizes the transfer of vibrations to the gong stand. From time to time the gut string should be examined for wear and tear and, if necessary, be replaced. Each gong should be suspended so that it may swing freely forward, backward, and to the sides without touching the stand. Replacement gut string is available on request.

Transport and Handling of Gongs

Every Paiste Gong becomes a valuable musical instrument through the skillful craft and experience of the gong maker. Gongs should be handled with the same care that goes into making them. The following guidelines apply:

- Any kind of pressure, such as stepping on, denting, or pushing on may deform the gong and cause a change of sound.
- Gongs should not be set on their edge. They may fall over and the rim may be deformed.
- Gongs should always be laid face down. For transportation they should be placed within each other, face down. In order not to damage the surface, one should place some form of protection between gongs, such as blankets or rubber foam.
- The safest mode of transportation are strong card board boxes or wooden crates with rubber foam or blanket cushioning. Specially made Gong Cases (see page 27) are also available.

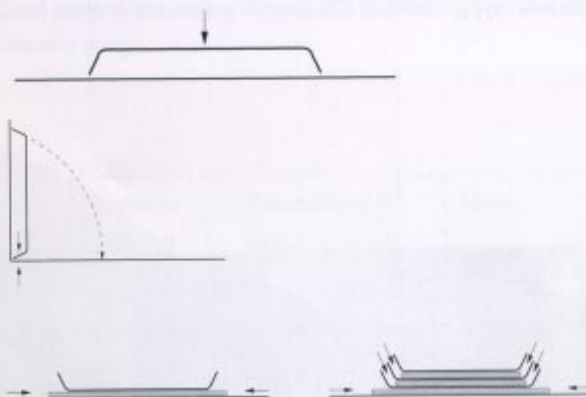

Care of Gongs

Gongs should be cleaned from time to time. Dirt, which builds up during set-up, playing and transporting, acts on the gong like a damper and inhibits its natural vibration.

Each Paiste Gong has a wax coating to guard against oxidizing and dirt build-up. During cleaning the wax coat is gradually removed and has to be replaced.

For cleaning, do not use grainy or acidic cleaning agents, as well as ones containing ammonia. Cleaning and waxing of the gong should always be done in the direction of the shaving (if present) on the gong surface and only with slight pressure. Use colorless and soft cloth.

Apply the cleaning agent to the cloth and clean the gong. Rub off any remaining cleaning fluid with two or three more pieces of cloth. Then apply a wax coat. Best suited is a fluid clear wax, such as is usually sold for cleaning and protecting wooden surfaces.

Inscription of the Gong

Paiste Gongs are supplied with the Paiste logo. By request, gongs may be made without logo or with Chinese signs (see page 27), or with individual inscriptions or logos.

Designation of Sizes

All sizes are designated in inch/cm, for example: 60"/150 cm.

Designation of Pitches

8^{ve}

B1	C2	D2	E2	F2	G2	A2	B2	C3	D3	E3	F3	G3	A3	B3	C4	D4	E4	F4	G4	A4	B4	C5	D5	E5	F5	G5	A5	B5	C6	D6	E6	F6	G6	A6	B6	C7	D7	E7	F7	G7	A7	B7	C8
H1	C	D	E	F	G	A	H	c	d	e	f	g	a	h	c'	d'	e'	f'	g'	a'	h'	c''	d''	e''	f''	g''	a''	h''	c'''	d'''	e'''	f'''	g'''	a'''	h'''	c''''	d''''	e''''	f''''	g''''	a''''	h''''	c'''''
S11	DO2	RE2	M2	FA2	SOL2	LA2	S12	DO3	RE3	M3	FA3	SOL3	LA3	S13	DO4	RE4	M4	FA4	SOL4	LA4	S14	DO5	RE5	M5	FA5	SOL5	LA5	S15	DO6	RE6	M6	FA6	SOL6	LA6	S16	DO7	RE7	M7	FA7	SOL7	LA7	S17	DO8

Paiste Gong Production

6

The sound of a gong is created through the skillful craft of the gong maker, guided by his intuitively experienced sound conception. He works the alloy until the desired sound becomes alive and can be experienced.

The final tuning of a gong is particularly difficult and has to be repeated often until the desired sound is reached.

The fascinating sound of the gong provides contention for the gong maker's formidable task.



The sound characteristic of Planet Gongs (PG) is comparable to that of Symphonic Gongs in diameters 20"/51 cm through 38"/96 cm. Planet gongs are tuned in conformity with the natural harmonic series based in the orbital properties of the Earth, the Moon, the Sun, and the Planets according to calculations of Hans Cousto. Thus they resonate in harmony with the cycles of the celestial bodies and communicate a distinct aspect of the 'music of the spheres' so amply quoted since the Antique. Their sound color is extremely mysterious and conveys an unusual, unfathomable atmosphere. The illustrations show some possible combinations of stands and gongs.

PG-Gong Stands see page 18. Mallets see page 26.

Planet Name	Planet Symbol	Duration of Orbit in Days	Frequency		Pitch Note	Corresponds to Middle A in Hz	Paiste Gong-Ø		Note
			in Hz	Octave steps			inch	cm	
Earth	♁	1 year, tropical	136.10	32	cis	432.10	38"	96 cm	C2 [♯] /CIS
Sun	☉	3.582E-10	126.22	-8	H	449.80	38"	96 cm	B1/H1
Pluto	♇	90737.2	140.25	40	cis	445.26	36"	91 cm	C2 [♯] /CIS
Mercury	♿	87.969	141.27	30	cis	448.51	34"	86 cm	C2 [♯] /CIS
Mars	♂	686.98	144.72	33	d	433.67	34"	86 cm	D2/D
Saturn	♄	10759.21	147.85	37	d	443.04	34"	86 cm	D2/D
Plat. Year		25920 years	172.06	47	f	433.56	32"	81 cm	F2/F
Jupiter	♃	4332.588	183.58	36	fis	436.62	30"	76 cm	F2 [♯] /FIS
Day Sidereal		0.997270	194.71	24	g	437.11	28"	71 cm	G2/G
Venus	♀	224.701	221.23	32	a	442.46	26"	66 cm	A2/A
Uranus	♅	30685.93	207.36	39	gis	439.37	26"	66 cm	G2 [♯] /GIS
Neptun	♆	60187.64	211.44	40	gis	448.02	26"	66 cm	G2 [♯] /GIS
Moon Syn.	☾	29.530588	210.42	29	gis	445.86	26"	66 cm	G2 [♯] /GIS
Moon Sid.	☾	27.321661	227.43	29	ais	429.33	24"	61 cm	A2 [♯] /AIS

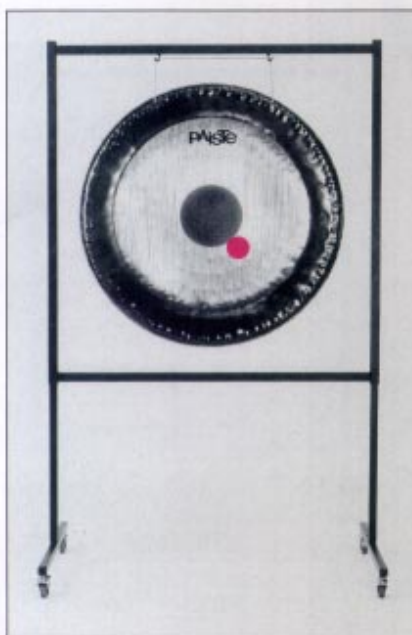

PG Mercury
Square Stand, black, with rollers

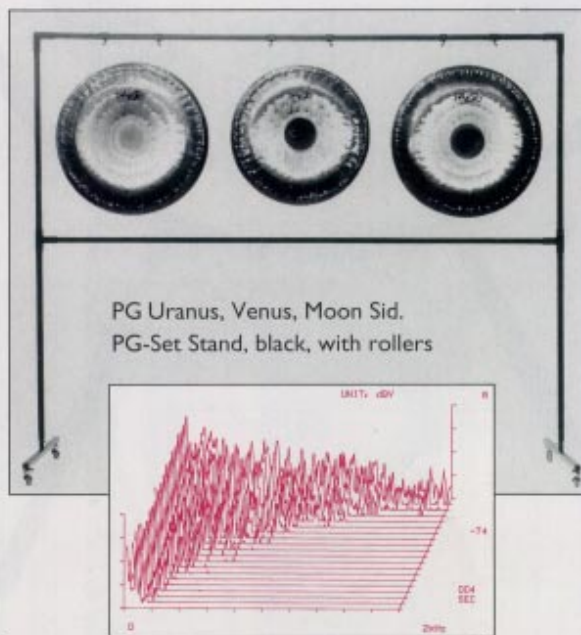

Sound Visualization PG Earth

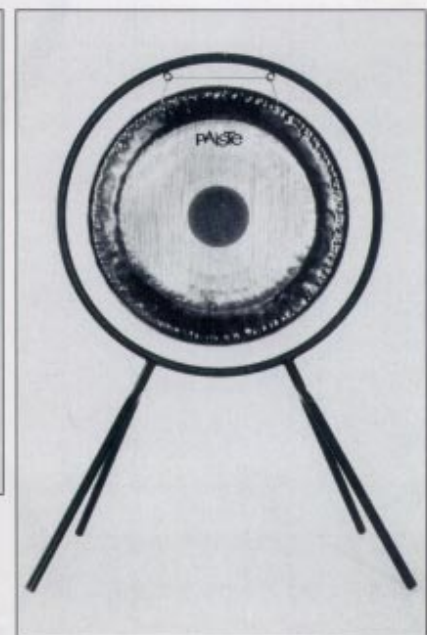

PG Mars
Round Stand, black

Symphonic Gongs (SG) are flat gongs with a harmonic and universal sound structure. The sound character of these gongs can be influenced and varied through the nature of the stroke, as well as the size, weight, and composition of the mallets. By varying the striking points, highs, lows, and various sound mixtures contained in the entirety of the gong's sound sphere may be extracted and played up.

Symphonic Gongs have the following sound characteristics:

- 60"/150 cm SG: builds steady and continuous in its vibration, from carrying lows to roaring, dense highs.
- 60"/150 cm SGM: builds quickly and responds easily in its vibration, from carrying lows to thundering, spraying highs.
60"/150 cm SGM (Symphonic Gong «Mikrophonie I») is a recreation of the 60"/150 cm SG from the 1960s. Because of its flexibility and extreme ability to react it is well suited for the performance of contemporary music, for example «Mikrophonie I» by Karlheinz Stockhausen.
- 50"/125 cm SG: reacts like a 60"/150 cm SGM.
- 40"/102 cm SG: reacts like a 60"/150 cm SG.
- 20"/51 cm – 38"/96 cm SG: reaction falls in between the 60"/150 cm SG and 60"/150 cm SGM.

The following illustrations show some combinations of stands and gongs.

- Stands see page 18.
- Mallets see page 26.

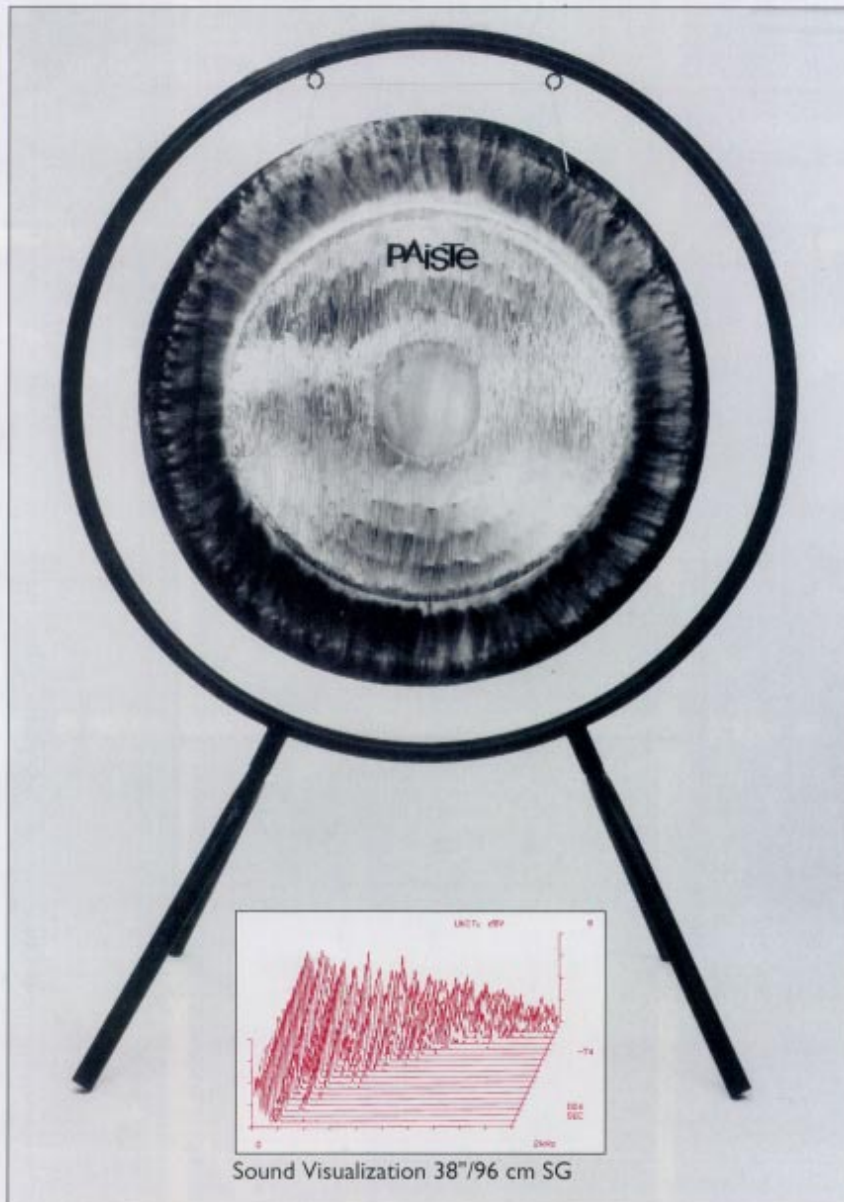

60"/150 cm SG
Round Stand, black

Sound Visualization 38"/96 cm SG

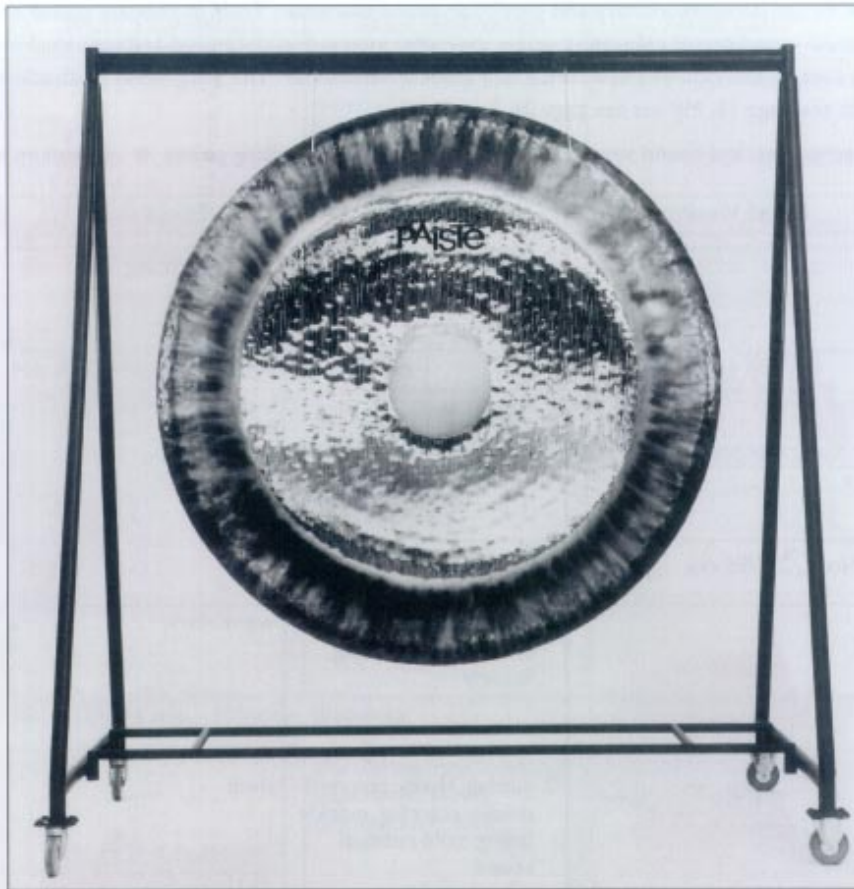

60"/150 cm SGM, Special Stand, black with rollers

	SGM													
SG	∅ 20"	∅ 22"	∅ 24"	∅ 26"	∅ 28"	∅ 30"	∅ 32"	∅ 34"	∅ 36"	∅ 38"	∅ 40"	∅ 50"	∅ 60"	∅ 80"
	51 cm	56 cm	61 cm	66 cm	71 cm	76 cm	81 cm	86 cm	91 cm	96 cm	102 cm	125 cm	150 cm	200 cm

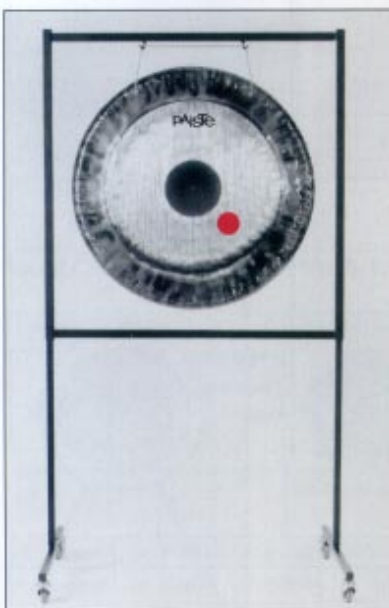

28"/71 cm SG
Square Stand, black with rollers

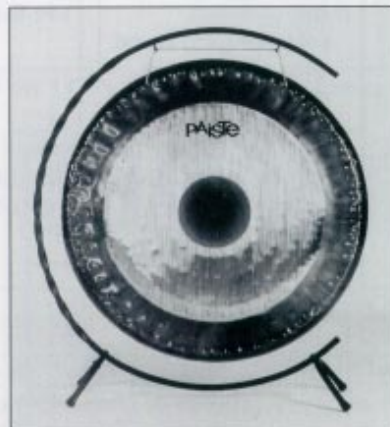

32"/81 cm SG
Floor Stand, black

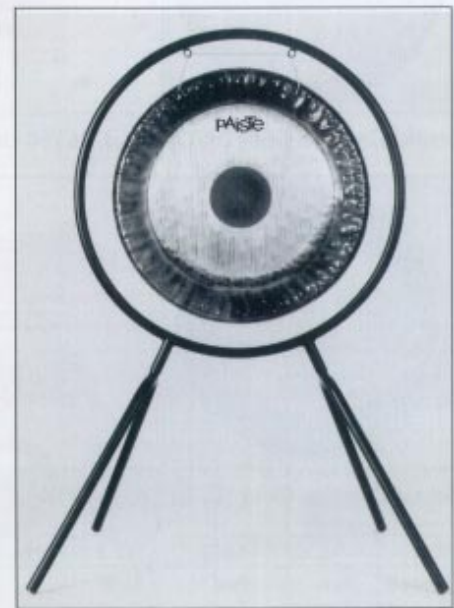

30"/76 cm SG
Round Stand, black

Each Sound Creation Gong (SCG) has an extraordinary and particular sound character. Their impressive sound charisma provides emotionally influencing sensations. Due to their varied sound colors and voices they offer interesting, diversified and individual forms of expression. All Sound Creation Gong designations are to be understood in a symbolical and associative manner. The gong stand illustrations show some possibilities of combination. SCG-Gong Stands see page 18. Mallets see page 26.

Sound visualizations, sound descriptions, and sound sensations refer to the indicated striking points ● at medium stroke intensity.

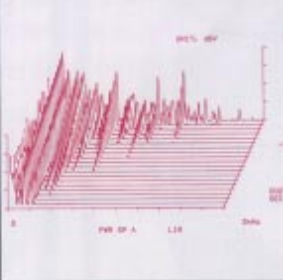
	Sound Visualization	Sound Description	Sound Color	Sound Sensation
		rising, softly structured, lasting, slow, continuously fading	warm-radiating	opening, warming, hopeful, positive, supporting

Sound Creation Gong (SCG) No. 1, 22"/56 cm, «Sun», «Beginning»

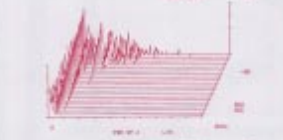
		1. delicately structured, dense, lasting, fading linearly	warm-dark	warm, soothing, sheltering
		2. cutting, sharp, pointed, quickly piercing, quickly fading, cold residual sound	shrill	aggressive, threatening, destructive

Sound Creation Gong (SCG) No. 2, 20"/51 cm, «Fire», «Rest-Aggression»

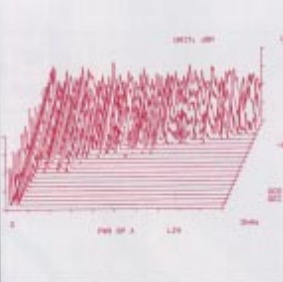
		alive, multi-layered structure, coarsely structured lows, finely structured highs, peaceful and wide lows, foaming and swelling highs, dissolving fade	unfathomable-dark	mysterious, unfathomable, knowing, remembering, allowing, inexorable, kind
---	---	--	-------------------	--

Sound Creation Gong (SCG) No. 3, 26"/66 cm, 32"/81 cm, 38"/96 cm, 60"/150 cm, «Earth», «Continuity»

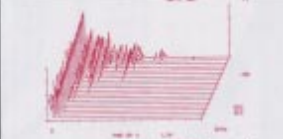
		1. still, unmoved, columnar, soft, round, deep, slowly fading, sinking	soft-dark	soothing, quiet lows, infinite, in-exhaustible
		2. concentrated, directive, continuous lows, flowing and striving highs, fading peacefully	streaming-dark, frothy highs	irresistible, sweeping, cleansing, flooding, clearing

Sound Creation Gong (SCG) No. 4, 24"/61 cm, «Water», «Energy»

SCG	No. 1	No. 2	No. 3	No. 3a	No. 3b	No. 3c	No. 4	No. 5	No. 6	No. 7	No. 8	No. 9	No. 10
Symbolic Expression	Sun Beginning	Fire Rest – Aggression	Earth Continuity				Water Energy	Peace Tolerance	Moon Evening	Fight Confrontation	Head	Chest	Stomach
∅	22"/56 cm	20"/51 cm	26"/66 cm	32"/81 cm	38"/96 cm	60"/150 cm	24"/61 cm	22"/56 cm	24"/61 cm	22"/56 cm	11"/28 cm	14"/36 cm	16"/40 cm

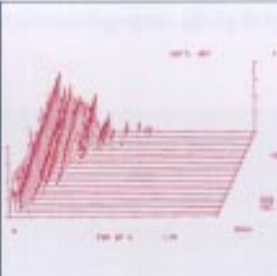
	Sound Visualization	Sound Description	Sound Color	Sound Sensation
		round, quiet, harmonic fade	soft lows, layering highs	balancing, harmonizing, soothing, supporting

Sound Creation Gong (SCG) No. 5, 22"/56 cm, «Peace», «Tolerance»

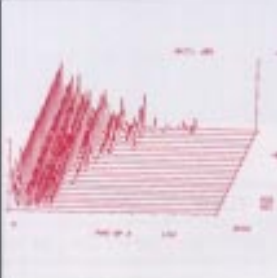
		full, dense, balanced, slowly sinking fade	deep-dark, with bright nucleus	gathering, enveloping, shielding, giving confidence, forgiving
---	---	--	--------------------------------	--

Sound Creation Gong (SCG) No. 6, 24"/61 cm, «Moon», «Evening»

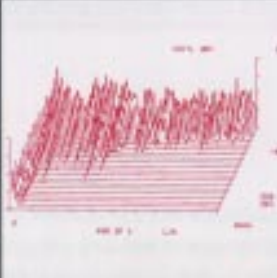
		thundering, raw, coarsely structured, slowly disintegrating fade	threatening-dark, bright, towering, hissing	challenging, threatening, attacking, discomforting
---	---	--	---	--

Sound Creation Gong (SCG) No. 7, 22"/56 cm, «Fight», «Confrontation»

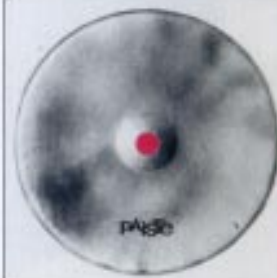
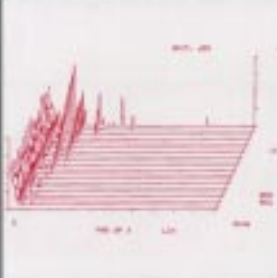
		harmonic, lasting, centered, penetrating, influencing, evenly fading	No. 8 bright No. 9 medium No. 10 dark	influencing, penetrating
---	---	--	---	--------------------------

Sound Creation Gong (SCG) No. 8, 9, 10, 11"/28 cm, 14"/36 cm, 16"/40 cm, Influence on body: «Head», «Chest», «Stomach»



SCG No. 3, Round Stand, black



SCG No. 4, Square Stand, black, with rollers

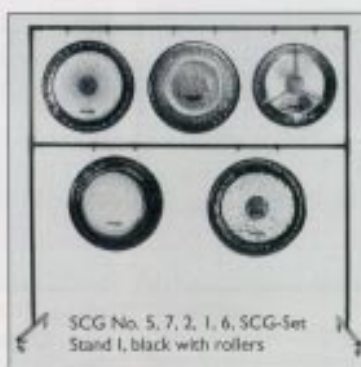

SCG No. 5, 7, 2, 1, 6, SCG-Set Stand I, black with rollers



SCG No. 8, 9, 10, 4, 3, SCG-Set Stand II, black, with rollers



SCG No. 8, 9, 10, SCG-Set Stand III, black, with rollers

Tuned Gongs (TG) are bossed gongs with a sound centered in the boss. They are tuned to a specific pitch, which is electronically controlled (Middle A - 440 Hz) can be made. Tuned Gongs are available individually or in any desired combination made up of gongs ranging from C2/C to F6/f^{'''}. Stands will be made according to your requirements. Tuned Gongs are an interesting addition for every ensemble.

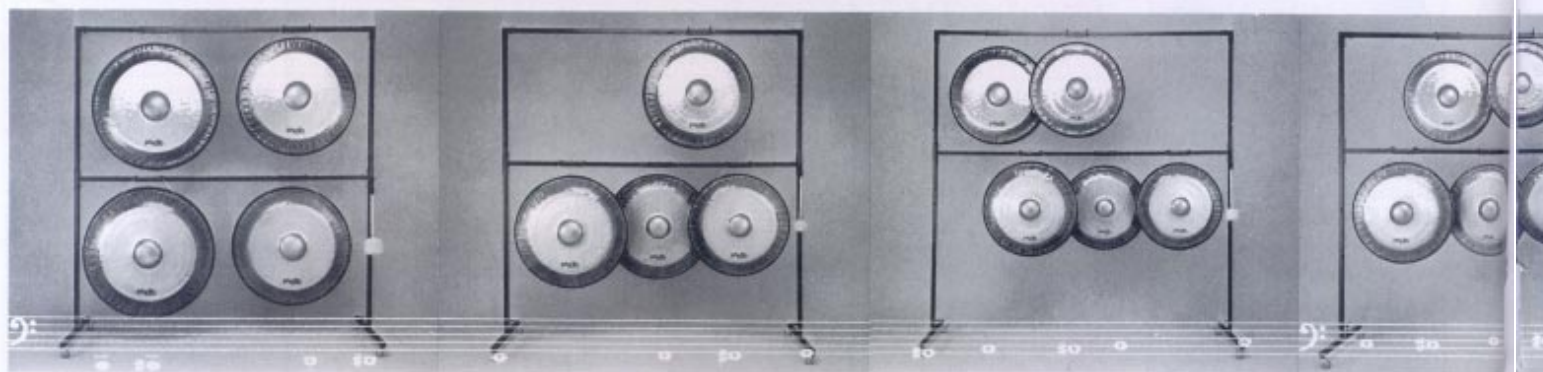

Tone	C2/C	C2 [♯] /CIS	D2/D	D2 [♯] /DIS	E2/E	F2/F	F2 [♯] /FIS	G2/G	G2 [♯] /GIS	A2/A	A2 [♯] /AIS	B2/H	C3/c	C3 [♯] /CIS
∅	36"/91 cm	36"/91 cm	34"/86 cm	32"/82 cm	31"/78 cm	30"/76 cm	30"/76 cm	28"/71 cm	28"/71 cm	26"/66 cm	26"/66 cm	24"/61 cm	23"/59 cm	22"/57 cm

Tone	D4 [♯] /dis'	E4/e'	F4/f'	F4 [♯] /fis'	G4/g'	G4 [♯] /gis'	A4/a'	A4 [♯] /ais'	B4/h'	C5/c''	C5 [♯] /cis''	D5/d''	D5 [♯] /dis''	E5/e''
∅	12"/30 cm	11"/28 cm	11"/28 cm	11"/28 cm	10"/26 cm	10"/26 cm	9"/24 cm	8 1/2"/22 cm	8 1/2"/22 cm	8 1/2"/22 cm	8 1/2"/22 cm	7"/18 cm	7"/18 cm	7"/18 cm

Tuned Percussion

Crotales

Crotales (Cymbales Antiques) have a clear and pure sound. Their tuning is electronically controlled (Middle A - 440 Hz). Any desired Hertz value for the middle A (e.g. 444 Hz) can be made. They are available as sets of either 2 chromatic octaves (F6/f^{'''} - F8/f^{''''}) or one chromatic octave (C7/c^{'''} - C8/c^{''''}). Naturally, they are also available individually. The floor stand for two octaves is available with or without a damper system, the single octave floor stand is only available without damper system. Stands see page 23. Mallets see page 26.

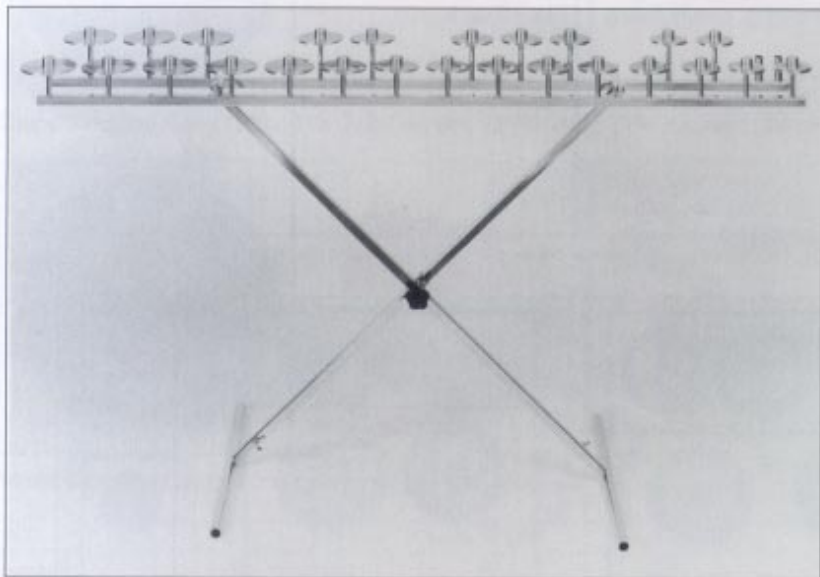

Crotales
Two Chromatic Octaves
Floor Stand without Damper System

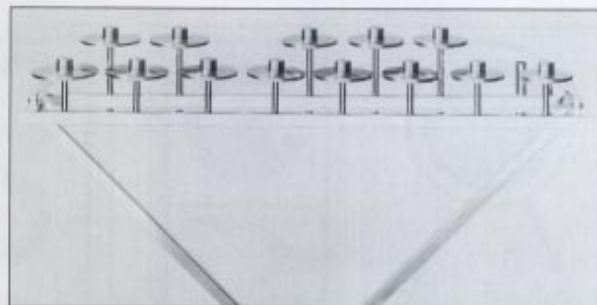

Crotales
Single Chromatic Octave
Floor Stand

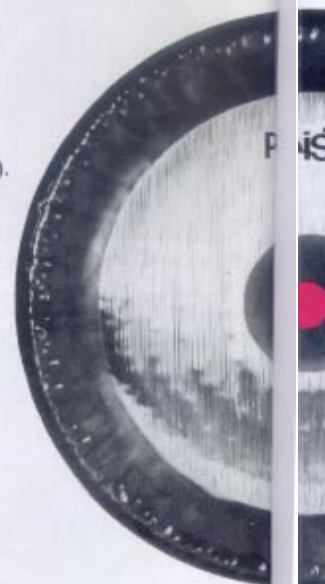

440 Hz) so that it is possible to play them together with other pitched musical instruments. Any desired Hertz value for the middle A (e.g. 444 Hz) can be made to the desired notes. Tuned Gong stands see page 18. Matching mallets see page 26. Due to their unique, soft and gong specific sound color, Tuned

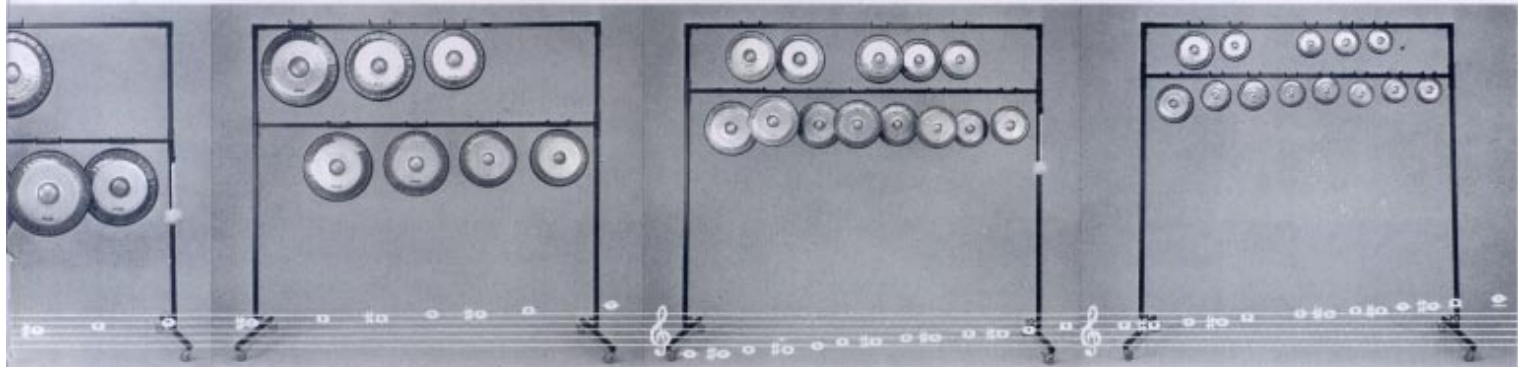

C3 [♯] /cis	D3/d	D3 [♯] /dis	E3/e	F3/f	F3 [♯] /fis	G3/g	G3 [♯] /gis	A3/a	A3 [♯] /ais	B3/h	C4/c'	C4 [♯] /cis'	D4/d'
22"/56 cm	22"/56 cm	20"/51 cm	20"/51 cm	19"/48 cm	18"/45 cm	16"/40 cm	16"/40 cm	15"/38 cm	14"/36 cm	13"/33 cm	13"/33 cm	12"/30 cm	12"/30 cm

E5/e ^{''}	F5/f ^{''}	F5 [♯] /fis ^{''}	G5/g ^{''}	G5 [♯] /gis ^{''}	A5/a ^{''}	A5 [♯] /ais ^{''}	B5/h ^{''}	C6/c ^{'''}	C6 [♯] /cis ^{'''}	D6/d ^{'''}	D6 [♯] /dis ^{'''}	E6/e ^{'''}	F6/f ^{'''}
7"/18 cm	6"/16 cm	6"/16 cm	6"/16 cm	6"/16 cm	6"/15 cm	6"/15 cm	6"/15 cm	6"/15 cm	6"/15 cm	6"/15 cm	6"/15 cm	6"/15 cm	6"/15 cm



Tuned Discs

Tuned discs feature a unique clear, warm, brilliant sound and a lasting tone. Their tuning is electronically controlled (Middle A - 440 Hz) and guarantees precise pitch. Any desired Hertz value for the middle A (e.g. 444 Hz) can be made. They are available as sets of either 2 chromatic octaves (C6/c^{'''} - C8/c^{''''}) or one chromatic octave (C7/c^{'''} - C8/c^{''''}). Naturally, they are also available individually. The floor stand for two octaves is available with or without a damper system, the single octave floor stand is only available without damper system. Stands see page 23. Mallets see page 26.

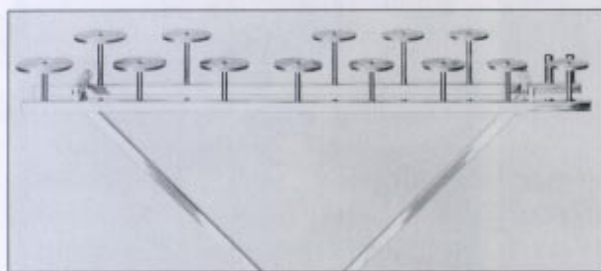
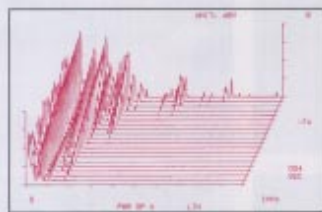

Tuned Discs
Single Chromatic Octave
Floor Stand

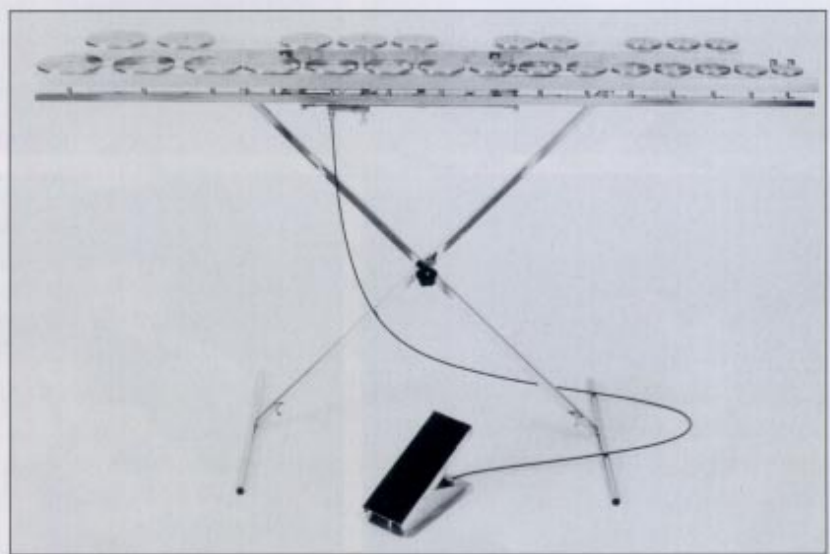

Tuned Discs
Two Chromatic Octaves
Floor Stand with Damper System

The various work processes in the creation of sounds place a multitude of demands on the abilities of the sound maker. Craftsmanship is as necessary as technical precision in the manufacture of gong and cymbal products. Aside from musical perception, the electronically precise fine tuning of the various sound objects is extremely important. Under these circumstances hardly any limits are placed on the wealth of ideas in the realization of sounds.

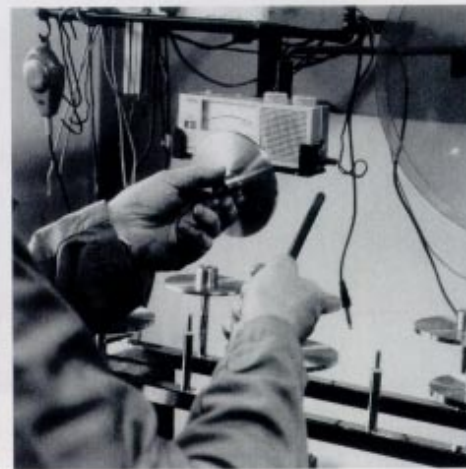
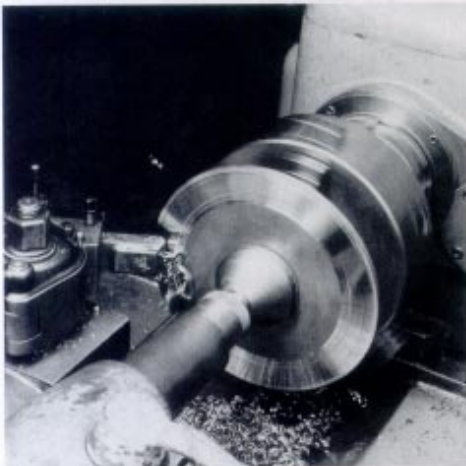
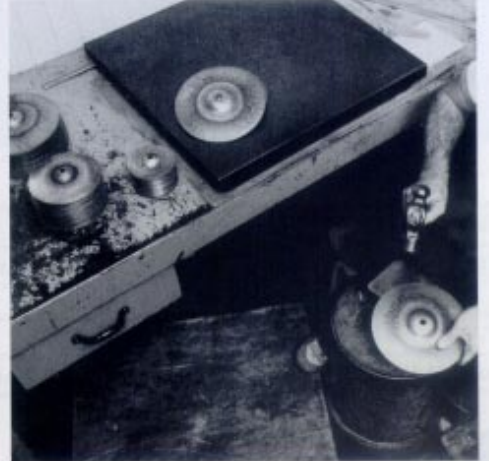

Paiste Sounds offer countless possibilities to rediscover and examine sound worlds ever anew. This is true in all areas where the invention and modification of sounds forms an integral part of the creative process.

Sound Plates

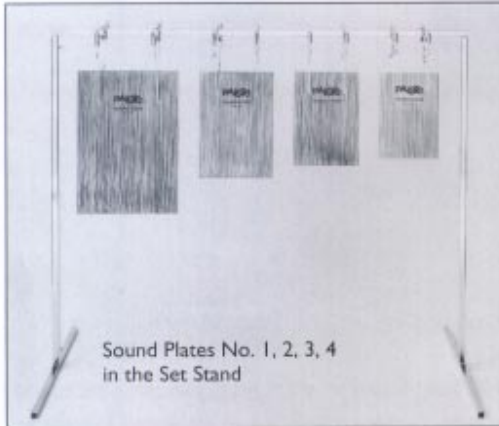

Sound Plates No. 1, 2, 3, 4 in the Set Stand



Sound Plate No. 4

Rotosound

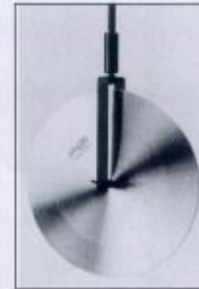

Rotosound No. 1

Sound Plates are rectangular bronze plates. The plates have a bell-like sound with very long sustain. They are arranged in even intervals. They are suspended by springs and can thus swing freely. Played with various mallets or sticks they unfold diverse and unusual tones and sounds. Sound Plates are available individually or as a set of four.

Stand see page 23. Mallets see page 26.

Spare springs and strings are available by request.

A Rotosound is a round bronze disc which tapers off towards the edge. Its particular holder allows the rotation of the disc and results in a vibrato effect with long sustain.

Rotosound Holder see page 25.

Mallets see page 26.

	No. 1	No. 2	No. 3	No. 4
∅	18" × 12" / 45 × 31 cm	13" × 9" / 33 × 23 cm	12" × 8" / 30 × 21 cm	10 1/2" × 7 1/2" / 27 × 19 cm

	No. 1	No. 2	No. 3
∅	9" / 23 cm	8" / 20 cm	7" / 17 cm

Cup Chimes



Cup Chimes No. 1, 2, 3, 4, 5, 6, 7 on Cup Chime Holder, chromed

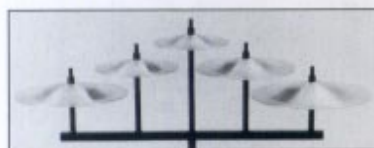

Cup Chimes No. 1, 2, 4, 6, 7 on Set Holder, black



Cup Chime No. 6

Cup Chimes are a set of seven small cymbals with large bells and narrow rims. Their sound is lively, exotic, and are arranged in intervals. Cup Chimes are available individually or in any desired combination. The 7Arm Cup Chime Holder may be mounted on any cymbal stand. The 5Arm Cup Chime Holder may be mounted on the Multisound Holder.

Multisound Holder and Cymbal Holder see page 25. Set Holders see pages 24, 25.

Mallets see page 26.

Sound Discs



Sound Discs No. 1, 3, 5 Sound Disc No. 1



Sound Discs have the same sound characteristics as Tuned Discs, but are not tuned to pitch. Sound Discs may be played individually or in any desired combination. They are available in 5 different sizes. Mallets see page 26. Spare string is available by request.

Cup Chimes	No. 1	No. 2	No. 3
∅	8" / 20 cm	7 1/2" / 19 cm	7" / 17 cm
No. 4	No. 5	No. 6	No. 7
6" / 16 cm	6" / 15 cm	5 1/2" / 14 cm	5" / 12,5 cm

Sound Discs	No. 1	No. 2
∅	6" / 14,5 cm	5 1/2" / 13,5 cm
No. 3	No. 4	No. 5
5" / 12,5 cm	4 1/2" / 11,5 cm	4" / 10,5 cm

Accent Gongs

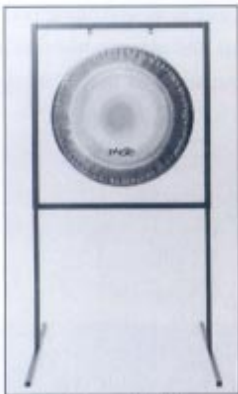

Accent Gong 22"/56 cm in Square Stand, black

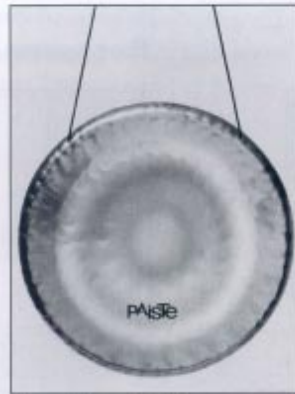

Accent Gong 10"/26 cm

Accent Gongs are special gongs with an aggressive, foaming, and lively sound character. A multitude of sounds may be achieved with various playing techniques. Accent Gongs are available in four sizes.

Gong Stands see page 18. Mallets see page 26.

Spare gut string is available by request.

∅	22"/56 cm	13"/33 cm
∅	10"/26 cm	7"/18 cm

Finger Cymbals

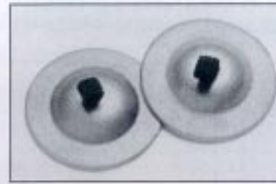

Finger Cymbals 2"/5 cm with elastic strap



Finger Cymbals 2"/5 cm 2 pieces stringed



Finger Cymbals 2"/5 cm string of 15 pieces

Very thick cymbals of 2"/5cm diameter with silvery high, musical sound character with long sustain. Finger cymbals are available individually or in any desired quantity. They may be played individually, in pairs, or strung together.

Mallets see page 26.

Spare elastic straps and string are available by request.

Finger Cymbals ∅	2"/5 cm
------------------	---------

Percussion Cymbals «Extra Thin»

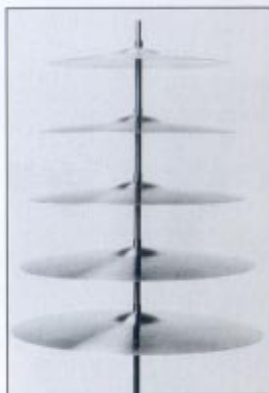

Percussion Cymbals No. 1, 2, 3, 4, 5 on Percussion Cymbal Holder, 5Arm



Percussion Cymbal No. 5

Very thin and delicate cymbals with Crash / Splash character. The cymbals may be stacked on top of each other with Mounting Rods into a cymbal tree, which may in turn be mounted on a cymbal stand. Percussion Cymbals are available individually or in sets of up to five sizes. Percussion Cymbal Holder 5Arm see page 24. Cymbal Holder see page 25. Mallets see page 26.

Percussion Cymbals	No. 1	No. 2
∅	15"/38 cm	14"/36 cm
No. 3	No. 4	No. 5
13"/33 cm	12"/30 cm	11"/28 cm

Accent Cymbals

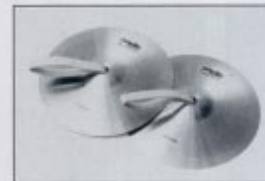

Accent Cymbals 8"/20 cm with leather straps



Accent Cymbal 8"/20 cm



Accent Cymbals three pairs of two cymbals each

These musical, small cymbals are available individually or in pairs. Played in various ways, they provide interesting sound effects.

Cymbal Holder see page 25.

Mallets see page 26.

Spare leather straps and spare string are available by request.

Accent Cymbals ∅	4"/10 cm	6"/15 cm	8"/20 cm
------------------	----------	----------	----------

Multisound Holder - Combination Possibilities

17

The Multisound Holder may be affixed to Square Stands, Round Stands, Set Stands, and Cymbal Stands. Sizes and specifications see page 25.

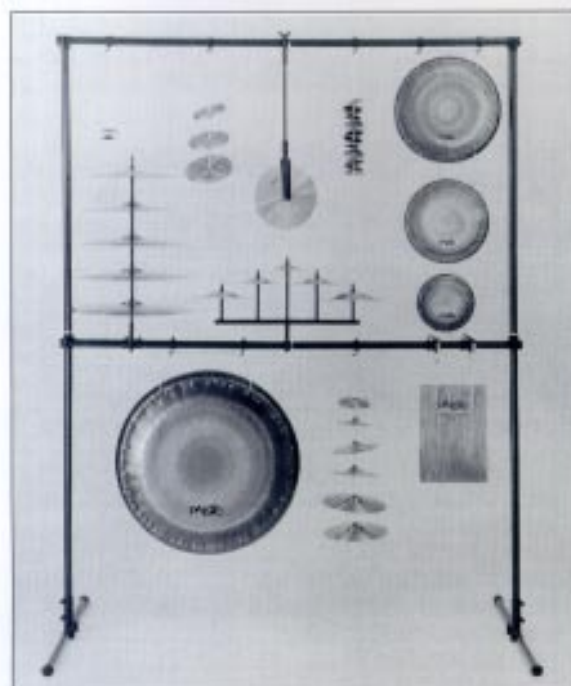
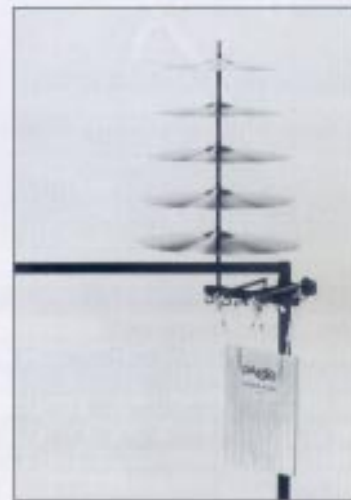
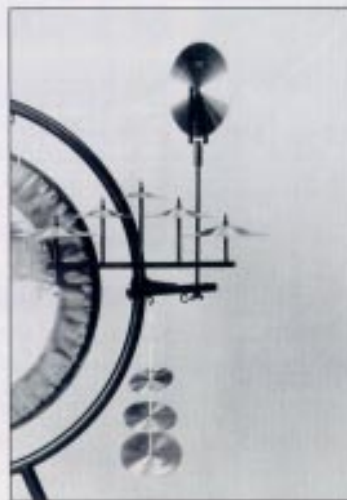
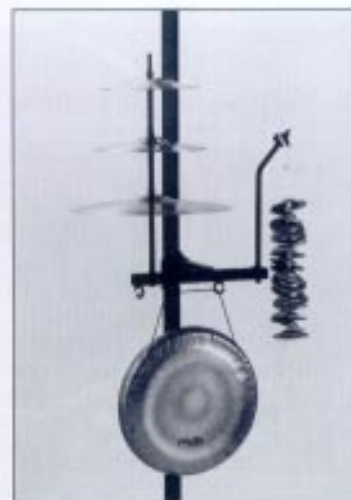
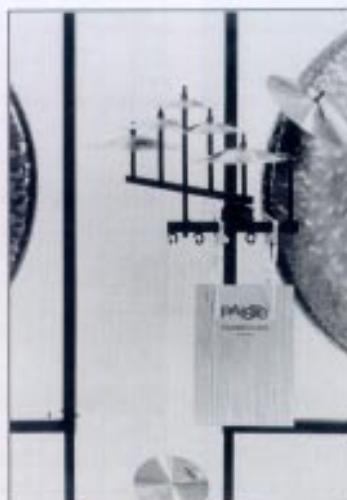

Percussion Set

The Percussion Set offers an abundance of possibilities to unfold musical and creative vigor. More than twenty cymbals, gongs, and sound objects are united in one set. An extremely wide sound spectrum is thus available.

- Percussion Set:
 Four Accent Gongs: No. 1, 2, 3, 4
 Three Sound Discs: No. 1, 4, 5
 One Rotosound: No. 1
 One Sound Plate: No. 2
 Percussion Cymbals "Extra Thin": No. 1, 2, 3, 4, 5
 Accent Cymbals 4"/10 cm, 6"/15 cm, 8"/20 cm, three pairs
 Finger Cymbals: 2 pieces on string, 15 piece row
 Cup Chimes: No. 1, 2, 4, 6, 7

Square Stands

Gong Diameter	20"/51 cm 22"/56 cm	24"/61 cm 26"/66 cm	28"/71 cm	30"/76 cm	32"/ 81 cm 34"/ 86 cm	36"/ 91 cm 38"/ 96 cm 40"/102 cm	50"/125 cm
Width	28"/70 cm	32"/80 cm	34"/86 cm	38"/96 cm	42"/106 cm	46"/117 cm	60"/150 cm
Height adjustable from-to	Type A 31"-53" 78-135 cm	Type A 34"-61" 88-156 cm	Type A 37"-66" 94-168 cm	41"-74" 104-188 cm	45"-82" 114-208 cm	51"-86" 127-220 cm	63"-86" 160-220 cm
Height adjustable from-to	Type B 31"-74" 78-188 cm	Type B 34"-74" 88-188 cm	Type B 37"-74" 94-188 cm				

Available in black finish, with or without rollers.

Round Stands

Gong Diameter	20"/ 51 cm 22"/ 56 cm	24"/ 61 cm 26"/ 66 cm	28"/ 71 cm	30"/ 76 cm	32"/ 81 cm 34"/ 86 cm	36"/91 cm 38"/96 cm
Width	29"/ 73 cm	32"/ 82 cm	35"/ 89 cm	38"/ 97 cm	42"/105 cm	50"/126 cm
Height	52"/133 cm	56"/142 cm	58"/148 cm	64"/162 cm	66"/168 cm	76"/192 cm

Available in black finish.

Floor Stands

Gong Diameter	20" 51 cm	22" 56 cm	24" 61 cm	26" 66 cm	28" 71 cm	30" 76 cm	32" 81 cm	34" 86 cm	36" 91 cm	38" 96 cm
Width	25" 63 cm	28" 70 cm	30" 75 cm	32" 81 cm	34" 86 cm	37" 94 cm	39" 100 cm	43" 108 cm	45" 114 cm	47" 119 cm
Height	26" 65 cm	30" 77 cm	32" 82 cm	34" 87 cm	36" 92 cm	39" 98 cm	42" 106 cm	44" 111 cm	47" 118 cm	49" 123 cm

Available in black finish.

Special Stands

Gong Diameter	60"/150 cm	80"/200 cm
Width	76"/194 cm	100"/254 cm
Height	84"/213 cm	108"/275 cm

Available in black finish, with rollers.

TG-Set Stands

Gong Notes	C2-D2 [‡]	E2-G2	G2 [‡] -C3	C3-F3	F3 [‡] -C4	C4-C5	C5-C6
Width	80"/204 cm	80"/204 cm	80"/204 cm	80"/204 cm	80"/204 cm	80"/204 cm	70"/179 cm
Height adjustable from-to	71"-86" 180-220 cm	71"-86" 180-220 cm	71"-86" 180-220 cm	71"-86" 180-220 cm	71"-86" 180-220 cm	71"-86" 180-220 cm	71"-86" 180-220 cm

Available in black finish, with rollers.

SCG, PG-Set Stands

	SCG SET I	SCG SET II	SCG SET III	PG SET
Width	74"/189 cm	66"/169 cm	23"/59 cm	88"/224 cm
Height adjustable from-to	71"-86" 180-220 cm	71"-86" 180-220 cm	41"-74" 105-188 cm	71"-86" 180-220 cm

Available in black finish, with rollers.

Square Stands

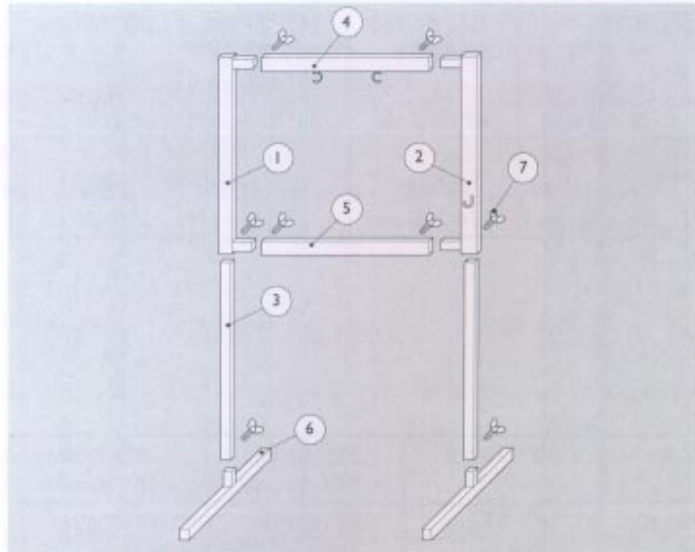

For Gong Diameter 20"/51 cm, 22"/56 cm				
No.	Qty.	Description	TYPE A	Item No.
1	1	Upper Vertical Bar Left 29"/73 cm		SP00010020
2	1	Upper Vertical Bar Right 29"/73 cm		SP00010120
3	2	Lower Vertical Bar 29"/73 cm		SP00010220
4	1	Upper Cross Bar 25"/64 cm		SP00010320
5	1	Lower Cross Bar 25"/64 cm		SP00010420
6	2	Foot 24"/60 cm		SP00011000
7	8	Wing Screw M8 × 16		SP00099020

For Gong Diameter 24"/61 cm, 26"/66 cm				
No.	Qty.	Description	TYPE A	Item No.
1	1	Upper Vertical Bar Left 33"/83 cm		SP00010024
2	1	Upper Vertical Bar Right 33"/83 cm		SP00010124
3	2	Lower Vertical Bar 33"/83 cm		SP00010224
4	1	Upper Cross Bar 29"/74 cm		SP00010324
5	1	Lower Cross Bar 29"/74 cm		SP00010424
6	2	Foot 24"/60 cm		SP00011000
7	8	Wing Screw M8 × 16		SP00099020

For Gong Diameter 28"/71 cm				
No.	Qty.	Description	TYPE A	Item No.
1	1	Upper Vertical Bar Left 35"/89 cm		SP00010028
2	1	Upper Vertical Bar Right 35"/89 cm		SP00010128
3	2	Lower Vertical Bar 35"/89 cm		SP00010228
4	1	Upper Cross Bar 32"/80 cm		SP00010328
5	1	Lower Cross Bar 32"/80 cm		SP00010428
6	2	Foot 24"/60 cm		SP00011000
7	8	Wing Screw M8 × 16		SP00099020

For Gong Diameter 20"/51 cm, 22"/56 cm				
No.	Qty.	Description	TYPE B	Item No.
1	1	Upper Vertical Bar Left 29"/73 cm		SP00010020
2	1	Upper Vertical Bar Right 29"/73 cm		SP00010120
3	2	Lower Vertical Bar 47"/120 cm		SP00010299
4	1	Upper Cross Bar 25"/64 cm		SP00010320
5	1	Lower Cross Bar 25"/64 cm		SP00010420
6	2	Foot 24"/60 cm		SP00011000
7	8	Wing Screw M8 × 16		SP00099020

For Gong Diameter 24"/61 cm, 26"/66 cm				
No.	Qty.	Description	TYPE B	Item No.
1	1	Upper Vertical Bar Left 33"/83 cm		SP00010024
2	1	Upper Vertical Bar Right 33"/83 cm		SP00010124
3	2	Lower Vertical Bar 47"/120 cm		SP00010299
4	1	Upper Cross Bar 29"/74 cm		SP00010324
5	1	Lower Cross Bar 29"/74 cm		SP00010424
6	2	Foot 24"/60 cm		SP00011000
7	8	Wing Screw M8 × 16		SP00099020

For Gong Diameter 28"/71 cm				
No.	Qty.	Description	TYPE B	Item No.
1	1	Upper Vertical Bar Left 35"/89 cm		SP00010028
2	1	Upper Vertical Bar Right 35"/89 cm		SP00010128
3	2	Lower Vertical Bar 47"/120 cm		SP00010299
4	1	Upper Cross Bar 32"/80 cm		SP00010328
5	1	Lower Cross Bar 32"/80 cm		SP00010428
6	2	Foot 24"/60 cm		SP00011000
7	8	Wing Screw M8 × 16		SP00099020

For Gong Diameter 30"/76 cm				
No.	Qty.	Description		Item No.
1	1	Upper Vertical Bar Left 39"/99 cm		SP00010030
2	1	Upper Vertical Bar Right 39"/99 cm		SP00010130
3	2	Lower Vertical Bar 39"/99 cm		SP00010230
4	1	Upper Cross Bar 36"/90 cm		SP00010330
5	1	Lower Cross Bar 36"/90 cm		SP00010430
6	2	Foot 28"/70 cm		SP00011100
7	8	Wing Screw M8 × 16		SP00099020

For Gong Diameter 32"/81 cm, 34"/86 cm				
No.	Qty.	Description		Item No.
1	1	Upper Vertical Bar Left 43"/109 cm		SP00010032
2	1	Upper Vertical Bar Right 43"/109 cm		SP00010132
3	2	Lower Vertical Bar 43"/109 cm		SP00010232
4	1	Upper Cross Bar 39"/99 cm		SP00010332
5	1	Lower Cross Bar 39"/99 cm		SP00010432
6	2	Foot 28"/70 cm		SP00011100
7	8	Wing Screw M8 × 16		SP00099020

For Gong Diameter 36"/91 cm, 38"/96 cm, 40"/102 cm				
No.	Qty.	Description		Item No.
1	1	Upper Vertical Bar Left 48"/122 cm		SP00010036
2	1	Upper Vertical Bar Right 48"/122 cm		SP00010136
3	2	Lower Vertical Bar 48"/122 cm		SP00010236
4	1	Upper Cross Bar 43"/110 cm		SP00010336
5	1	Lower Cross Bar 43"/110 cm		SP00010436
6	2	Foot 32"/80 cm		SP00011200
7	8	Wing Screw M8 × 16		SP00099020

For Gong Diameter 50"/125 cm				
No.	Qty.	Description		Item No.
1	1	Upper Vertical Bar Left 61"/155 cm		SP00010050
2	1	Upper Vertical Bar Right 61"/155 cm		SP00010150
3	2	Lower Vertical Bar 61"/155 cm		SP00010250
4	1	Upper Cross Bar 56"/142 cm		SP00010350
5	1	Lower Cross Bar 56"/142 cm		SP00010450
6	2	Foot 39"/100 cm		SP00011300
7	8	Wing Screw M8 × 16		SP00099020

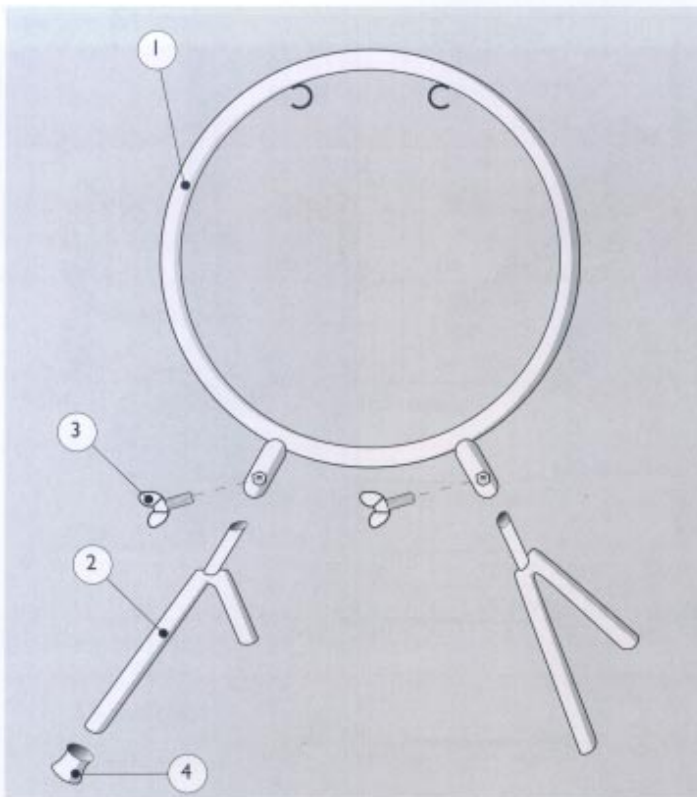

For Gong Diameter 20"/51 cm, 22"/56 cm			
No.	Qty.	Description	Item No.
1	1	Ring Outer Diameter 29"/73 cm	SP00020020
2	2	Leg 31"/78 cm	SP00021000
3	2	Wing Screw M8 × 16	SP00099020
4	4	Rubber Stop 25 mm	SP00099140

For Gong Diameter 24"/61 cm, 26"/66 cm			
No.	Qty.	Description	Item No.
1	1	Ring Outer Diameter 32"/82 cm	SP00020024
2	2	Leg 31"/78 cm	SP00021000
3	2	Wing Screw M8 × 16	SP00099020
4	4	Rubber Stop 25 mm	SP00099140

For Gong Diameter 28"/71 cm			
No.	Qty.	Description	Item No.
1	1	Ring Outer Diameter 35"/89 cm	SP00020028
2	2	Leg 31"/78 cm	SP00021000
3	2	Wing Screw M8 × 16	SP00099020
4	4	Rubber Stop 25 mm	SP00099140

For Gong Diameter 30"/76 cm			
No.	Qty.	Description	Item No.
1	1	Ring Outer Diameter 38"/97 cm	SP00020030
2	2	Leg 34"/86 cm	SP00021100
3	2	Wing Screw M8 × 16	SP00099020
4	4	Rubber Stop 33 mm	SP00099150

For Gong Diameter 32"/81 cm, 34"/86 cm			
No.	Qty.	Description	Item No.
1	1	Ring Outer Diameter 42"/105 cm	SP00020032
2	2	Leg 34"/86 cm	SP00021100
3	2	Wing Screw M8 × 16	SP00099020
4	4	Rubber Stop 33 mm	SP00099150

For Gong Diameter 36"/91 cm, 38"/96 cm, 40"/102 cm			
No.	Qty.	Description	Item No.
1	1	Ring Outer Diameter 50"/126 cm	SP00020036
2	2	Leg 37"/94 cm	SP00021200
3	2	Wing Screw M10 × 16	SP00099030
4	4	Rubber Stop 42 mm	SP00099160

Special Stands

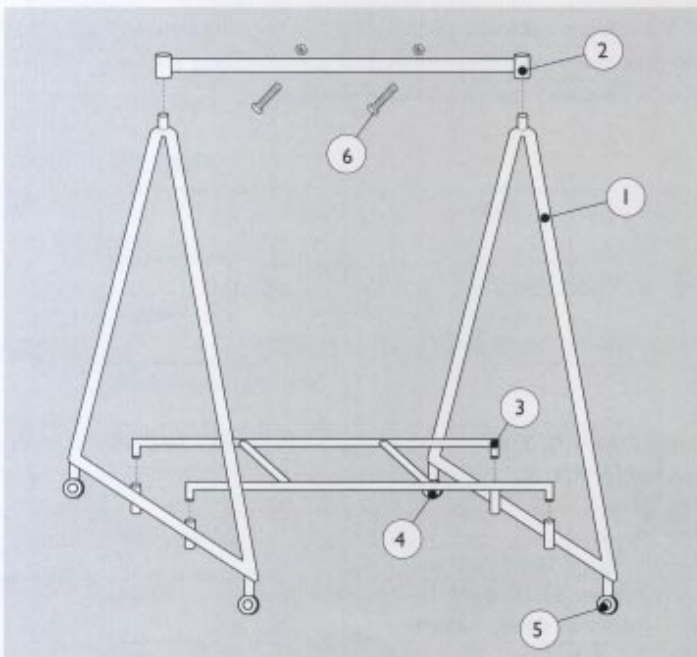

For Gong Diameter 60"/150 cm			
No.	Qty.	Description	Item No.
1	2	Vertical Frame 84"/213 cm	SP00015000
2	1	Upper Horizontal Bar 76"/194 cm	SP00015200
3	1	Lower Horizontal Frame	SP00015400
4	2	Roller without Lock Type GI	SP00099210
5	2	Roller with Lock Type GI	SP00099211
6	2	Screw and Nut M10 × 100	SP00099045

For Gong Diameter 80"/200 cm			
No.	Qty.	Description	Item No.
1	2	Vertical Frame 108"/275 cm	SP00015100
2	1	Upper Horizontal Bar 100"/254 cm	SP00015300
3	1	Lower Horizontal Frame	SP00015500
4	2	Roller without Lock Type GI	SP00099220
5	2	Roller with Lock Type GI	SP00099221
6	2	Screw and Nut M10 × 120	SP00099046

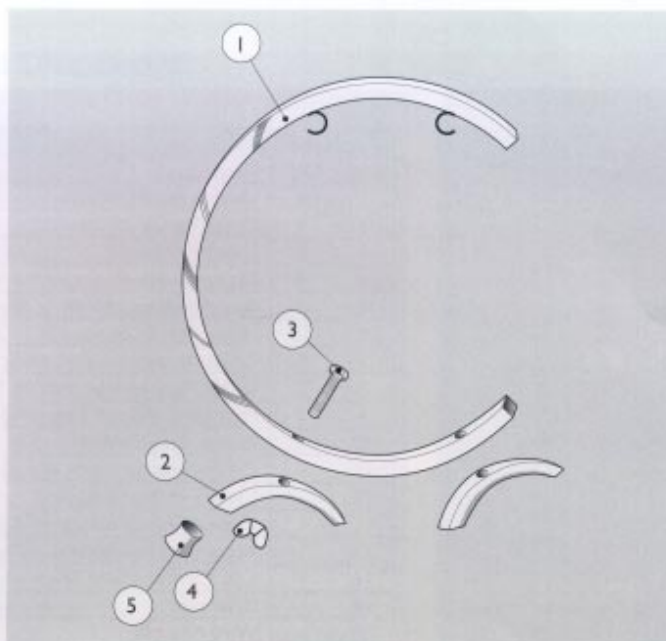

For Gong Diameter 20"/51 cm			
No.	Qty.	Description	Item No.
1	1	Forged Iron Ring \varnothing 25"/63 cm	SP00030020
2	2	Forged Iron Foot 10"/25 cm	SP00031000
3	2	Screw M6 \times 30	SP00099010
4	2	Wing Nut M6	SP00099041
5	4	Rubber Stop 14 mm	SP00099110

For Gong Diameter 30"/76 cm			
No.	Qty.	Description	Item No.
1	1	Forged Iron Ring \varnothing 37"/94 cm	SP00030030
2	2	Forged Iron Foot 12"/31 cm	SP00031010
3	2	Screw M6 \times 40	SP00099011
4	2	Wing Nut M6	SP00099041
5	4	Rubber Stop 16 mm	SP00099120

For Gong Diameter 22"/56 cm			
No.	Qty.	Description	Item No.
1	1	Forged Iron Ring \varnothing 28"/70 cm	SP00030022
2	2	Forged Iron Foot 12"/31 cm	SP00031010
3	2	Screw M6 \times 40	SP00099011
4	2	Wing Nut M6	SP00099041
5	4	Rubber Stop 16 mm	SP00099120

For Gong Diameter 32"/81 cm			
No.	Qty.	Description	Item No.
1	1	Forged Iron Ring \varnothing 39"/100 cm	SP00030032
2	2	Forged Iron Foot 12"/31 cm	SP00031010
3	2	Screw M6 \times 40	SP00099011
4	2	Wing Nut M6	SP00099041
5	4	Rubber Stop 16 mm	SP00099120

For Gong Diameter 24"/61 cm			
No.	Qty.	Description	Item No.
1	1	Forged Iron Ring \varnothing 30"/75 cm	SP00030024
2	2	Forged Iron Foot 12"/31 cm	SP00031010
3	2	Screw M6 \times 40	SP00099011
4	2	Wing Nut M6	SP00099041
5	4	Rubber Stop 16 mm	SP00099120

For Gong Diameter 34"/86 cm			
No.	Qty.	Description	Item No.
1	1	Forged Iron Ring \varnothing 42"/108 cm	SP00030034
2	2	Forged Iron Foot 12"/31 cm	SP00031010
3	2	Screw M6 \times 40	SP00099011
4	2	Wing Nut M6	SP00099041
5	4	Rubber Stop 16 mm	SP00099120

For Gong Diameter 26"/66 cm			
No.	Qty.	Description	Item No.
1	1	Forged Iron Ring \varnothing 32"/81 cm	SP00030026
2	2	Forged Iron Foot 12"/31 cm	SP00031010
3	2	Screw M6 \times 40	SP00099011
4	2	Wing Nut M6	SP00099041
5	4	Rubber Stop 16 mm	SP00099120

For Gong Diameter 36"/91 cm			
No.	Qty.	Description	Item No.
1	1	Forged Iron Ring \varnothing 45"/114 cm	SP00030036
2	2	Forged Iron Foot 13"/34 cm	SP00031015
3	2	Screw M6 \times 50	SP00099012
4	2	Wing Nut M6	SP00099041
5	4	Rubber Stop 20 mm	SP00099130

For Gong Diameter 28"/71 cm			
No.	Qty.	Description	Item No.
1	1	Forged Iron Ring \varnothing 34"/86 cm	SP00030028
2	2	Forged Iron Foot 12"/31 cm	SP00031010
3	2	Screw M6 \times 40	SP00099011
4	2	Wing Nut M6	SP00099041
5	4	Rubber Stop 16 mm	SP00099120

For Gong Diameter 38"/96 cm			
No.	Qty.	Description	Item No.
1	1	Forged Iron Ring \varnothing 47"/119 cm	SP00030038
2	2	Forged Iron Foot 13"/34 cm	SP00031015
3	2	Screw M6 \times 50	SP00099012
4	2	Wing Nut M6	SP00099041
5	4	Rubber Stop 20 mm	SP00099130

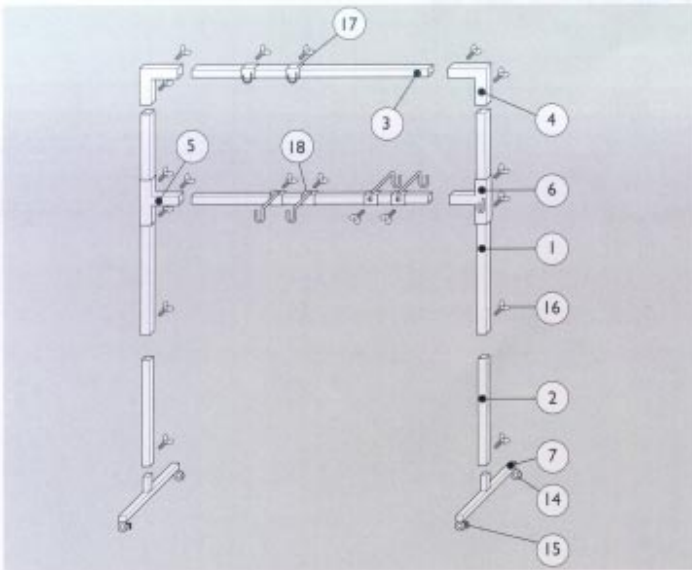

Set Stands No. I for SCG No. 2, 5, 7, 1, 6

No.	Qty.	Description	Item No.
1	2	Upper Vertical Bar 69"/175 cm	SP00040002
2	2	Lower Vertical Bar 39"/100 cm	SP00040003
3	2	Cross Bar 73"/185 cm	SP00040015
4	2	Corner Joint	SP00040020
5	1	T-joint Left	SP00040021
6	1	T-joint Right	SP00040022
7	2	Foot 28"/70 cm	SP00040032
14	2	Roller without Lock KType	SP00099200
15	2	Roller with Lock KType	SP00099201
16	14	Wing Screw M8 × 16	SP00099020
17	10	Short Hook with Screw	SP00099050

Set Stands for 2-3 PG depending on Diameter

No.	Qty.	Description	Item No.
1	2	Upper Vertical Bar 69"/175 cm	SP00040002
2	2	Lower Vertical Bar 39"/100 cm	SP00040003
3	2	Cross Bar 86"/220 cm	SP00040017
4	2	Corner Joint	SP00040020
5	1	T-joint Left	SP00040021
6	1	T-joint Right	SP00040022
7	2	Foot 28"/70 cm	SP00040032
14	2	Roller without Lock KType	SP00099200
15	2	Roller with Lock KType	SP00099201
16	14	Wing Screw M8 × 16	SP00099020
17	4-6	Short Hook with Screw	SP00099050

Set Stands No. II for SCG No. 8, 9, 10, 3, 4

No.	Qty.	Description	Item No.
1	2	Upper Vertical Bar 69"/175 cm	SP00040002
2	2	Lower Vertical Bar 39"/100 cm	SP00040003
3	2	Cross Bar 65"/165 cm	SP00040013
4	2	Corner Joint	SP00040020
5	1	T-joint Left	SP00040021
6	1	T-joint Right	SP00040022
7	2	Foot 28"/70 cm	SP00040032
14	2	Roller without Lock KType	SP00099200
15	2	Roller with Lock KType	SP00099201
16	14	Wing Screw M8 × 16	SP00099020
17	10	Short Hook with Screw	SP00099050

Set Stands for TG C2 - D2², E2 - G2, G2² - C3, C3 - F3, F3² - C4, C4 - C5

No.	Qty.	Description	Item No.
1	2	Upper Vertical Bar 69"/175 cm	SP00040002
2	2	Lower Vertical Bar 39"/100 cm	SP00040003
3	2	Cross Bar 78"/200 cm	SP00040016
4	2	Corner Joint	SP00040020
5	1	T-joint Left	SP00040021
6	1	T-joint Right	SP00040022
7	2	Foot 28"/70 cm	SP00040032
14	2	Roller without Lock KType	SP00099200
15	2	Roller with Lock KType	SP00099201
16	14	Wing Screw M8 × 16	SP00099020
17	8	C2 - D2² Short Hook with Screw	SP00099050
18	8	E2 - G2 Long Hook with Screw	SP00099060
18	10	G2² - C3 Long Hook with Screw	SP00099060
18	12	C3 - F3 Long Hook with Screw	SP00099060
17	14	F3² - C4 Short Hook with Screw	SP00099050
18	26	C4 - C5 Long Hook with Screw	SP00099060

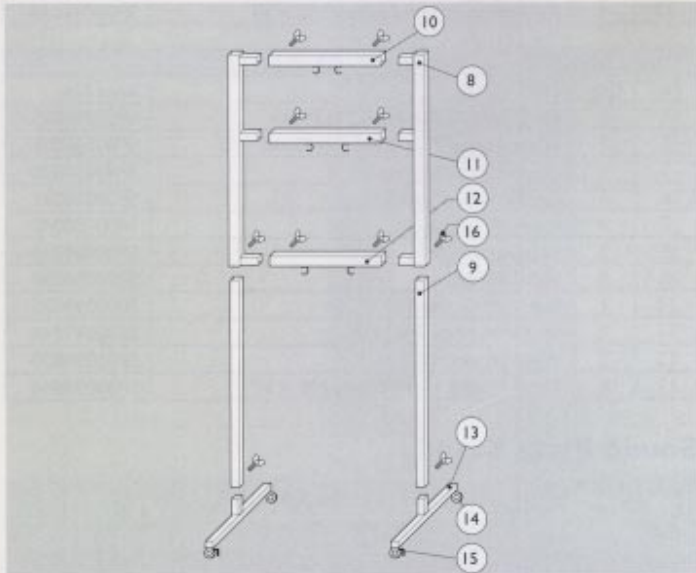

Set Stands for TG C5-C6

No.	Qty.	Description	Item No.
1	2	Upper Vertical Bar 69"/175 cm	SP00040002
2	2	Lower Vertical Bar 39"/100 cm	SP00040003
3	2	Cross Bar 69"/175 cm	SP00040014
4	2	Corner Joint	SP00040020
5	1	T-joint Left	SP00040021
6	1	T-joint Right	SP00040022
7	2	Foot 28"/70 cm	SP00040032
14	2	Roller without Lock KType	SP00099200
15	2	Roller with Lock KType	SP00099201
16	14	Wing Screw M8 × 16	SP00099020
17	26	C5 - C6 Short Hook with Screw	SP00099050

Set Stands No. III for SCG No. 8, 9, 10

No.	Qty.	Description	Item No.
8	2	Upper Vertical Bar 39"/100 cm	SP00040000
9	2	Lower Vertical Bar 39"/100 cm	SP00040001
10	1	Upper Cross Bar 22"/55 cm	SP00040010
11	1	Middle Cross Bar 22"/55 cm	SP00040011
12	1	Lower Cross Bar 22"/55 cm	SP00040012
13	2	Foot 24"/60 cm	SP00040030
14	2	Roller without Lock KType	SP00099200
15	2	Roller with Lock KType	SP00099201
16	10	Wing Screw M8 × 16	SP00099020

Crotales and Tuned Disc Stands

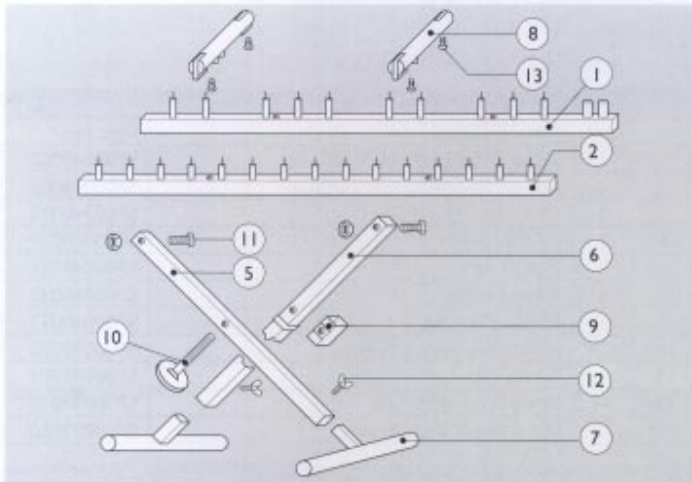

Crotales Stand 2 Octaves F6 - F8			
No.	Qty.	Description	Item No.
1	1	Back Crotales Bar 67"/170 cm	SP00050021
2	1	Front Crotales Bar 67"/170 cm	SP00050022
5	1	Leg Bar without Notch	SP00050030
6	1	Leg Bar with Notch	SP00050031
7	2	Foot 20"/50 cm	SP00050040
8	2	Bar Connector	SP00050045
9	1	Leg Connector	SP00050050
10	1	Star Grip Screw M8 × 35	SP00099075
11	2	Screw and Nut M6 × 35	SP00099044
12	2	Wing Screw M8 × 16	SP00099020
13	4	Countersunk Head Screw M8 × 30	SP00099048

Tuned Disc Stand 2 Octaves C6 - C8			
No.	Qty.	Description	Item No.
1	1	Back Tuned Disc Bar 67"/170 cm	SP00050025
2	1	Front Tuned Disc Bar 67"/170 cm	SP00050026
5	1	Leg Bar without Notch	SP00050030
6	1	Leg Bar with Notch	SP00050031
7	2	Foot 20"/50 cm	SP00050040
8	2	Bar Connector	SP00050045
9	1	Leg Connector	SP00050050
10	1	Star Grip Screw M8 × 35	SP00099075
11	2	Screw and Nut M6 × 35	SP00099044
12	2	Wing Screw M8 × 16	SP00099020
13	4	Countersunk Head Screw M8 × 30	SP00099048

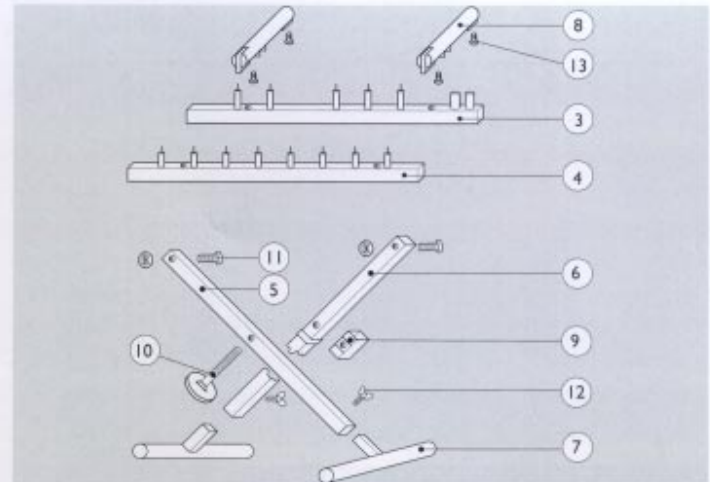

Crotales Stand 1 Octave C7 - C8			
No.	Qty.	Description	Item No.
3	1	Back Crotales Bar 34"/85 cm	SP00050010
4	1	Front Crotales Bar 34"/85 cm	SP00050011
5	1	Leg Bar without Notch	SP00050030
6	1	Leg Bar with Notch	SP00050031
7	2	Foot 20"/50 cm	SP00050040
8	2	Bar Connector	SP00050045
9	1	Leg Connector	SP00050050
10	1	Star Grip Screw M8 × 35	SP00099075
11	2	Screw and Nut M6 × 35	SP00099044
12	2	Wing Screw M8 × 16	SP00099020
13	4	Countersunk Head Screw M8 × 30	SP00099048

Tuned Disc Stand 1 Octave C7 - C8			
No.	Qty.	Description	Item No.
3	1	Back Tuned Disc Bar 34"/85 cm	SP00050015
4	1	Front Tuned Disc Bar 34"/85 cm	SP00050016
5	1	Leg Bar without Notch	SP00050030
6	1	Leg Bar with Notch	SP00050031
7	2	Foot 20"/50 cm	SP00050040
8	2	Bar Connector	SP00050045
9	1	Leg Connector	SP00050050
10	1	Star Grip Screw M8 × 35	SP00099075
11	2	Screw and Nut M6 × 35	SP00099044
12	2	Wing Screw M8 × 16	SP00099020
13	4	Countersunk Head Screw M8 × 30	SP00099048

Sound Plate Stand

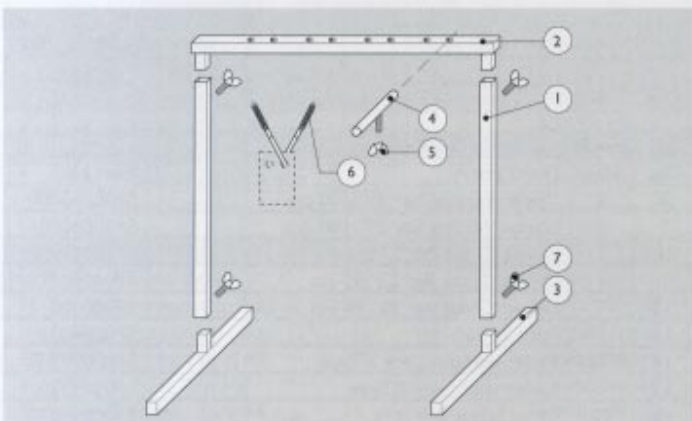

Sound Plate Stand			
No.	Qty.	Description	Item No.
1	2	Vertical Bar 40"/103 cm	SP00050000
2	1	Horizontal Bar 52"/131 cm	SP00050005
3	2	Foot 26"/65 cm	SP00050042
4	8	Sound Plate Holder	SP00050048
5	4	Wing Nut M8	SP00099042
6	8	Spring with Spring and Loop	SP00099275
7	4	Wing Screw M8 × 16	SP00099020

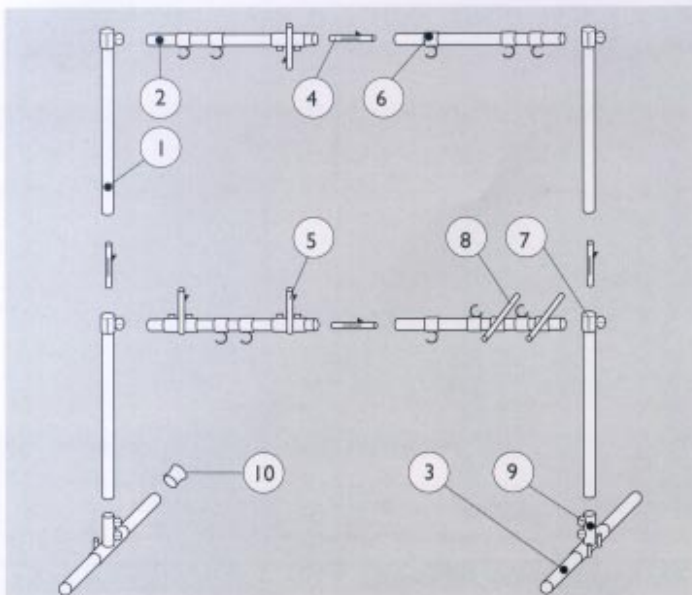

Percussion Set Stand			
No.	Qty.	Description	Item No.
1	4	Vertical Bar 35"/90 cm	SP00055010
2	4	Cross Bar 28"/70 cm	SP00055011
3	2	Foot 28"/70 cm	SP00055040
4	4	Bar Joint with 4K Screw M6 × 20	SP00055045
5	3	Sound Holder with 4K Screw M6 × 12 + 25	SP00055050
6	10	Hook with 4K Screw M6 × 25	SP00055055
7	2	Cross Bar Holder with 4K Screw M6 × 25	SP00055065
8	2	Sound Plate Holder with 4K Screw M6 × 25	SP00055075
9	2	Foot Joint with 4K Screw M6 × 25	SP00055070
10	4	Rubber Stop 25 mm	SP00099140
11	1	Cymbal Holder 5Arm with Grommets	SP00055100
12		Cymbal Holder Base Rod	SP00055110
13		Cymbal Holder Extension Rod	SP00055120
15	1	Rotosound Holder with Wing Nut M8	SP00055200
16	1	Cup Chime Holder 5Arm with Grommets	SP00055300
14		Grommet	SP00099180
20		Wing Nut M8	SP00099042
17		4K Screw M6 × 25	SP00099005
18		4K Screw M6 × 12	SP00099006
19		4K Screw M6 × 20	SP00099007

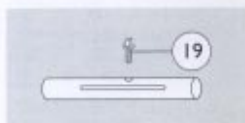

No. 4 Bar Joint

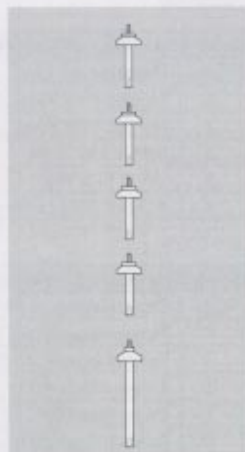

No. 11 Cymbal Holder 5Arm

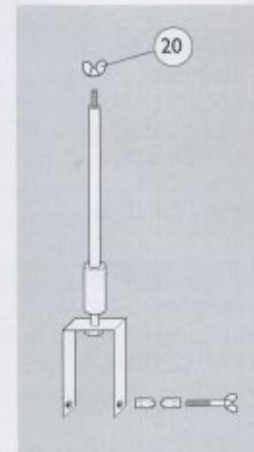

No. 15 Rotosound Holder

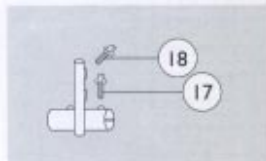

No. 5 Sound Holder

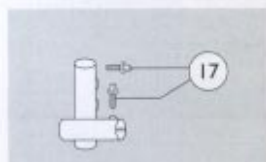

No. 9 Foot Joint



No. 12 Base Rod

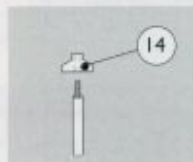

No. 13 Extension Rod

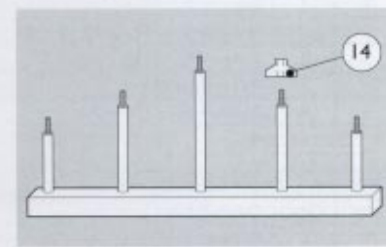

No. 16 Cup Chime Holder

Cup Chime Holder 7Arm

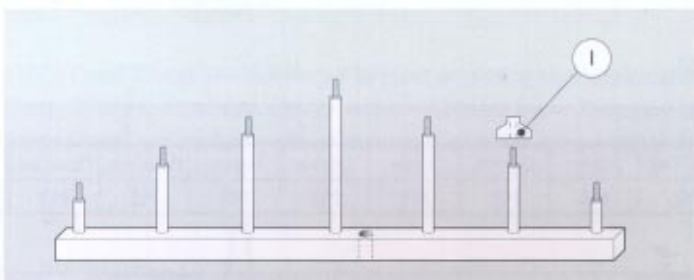

Cup Chime Holder 7Arm

No.	Qty.	Description	Item No.
		Cup Chime Holder 7Arm with Grommets	SP00056100
1		Grommet	SP00099180

Rotosound Holder

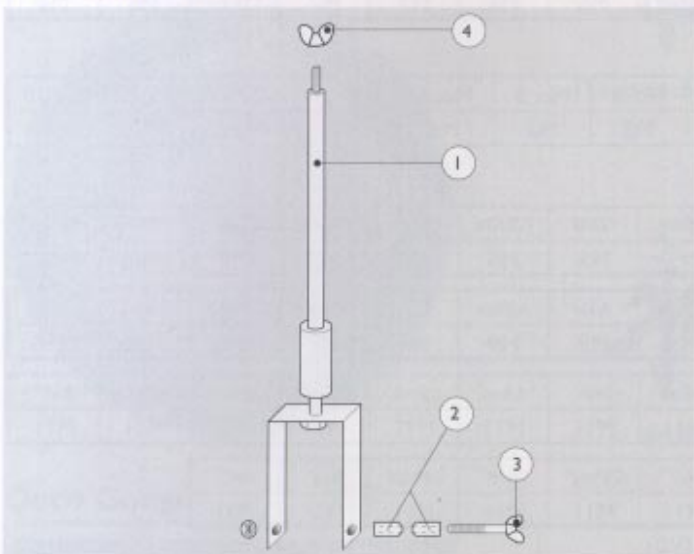

Rotosound Holder

No.	Qty.	Description	Item No.
		Rotosound Holder for \varnothing 7"/17 cm, 8"/20 cm	SP00057000
		Rotosound Holder for \varnothing 9"/23 cm	SP00057010
1	1	Rotosound Clamp \varnothing 7"/17 cm, 8"/20 cm	SP00057100
1	1	Rotosound Clamp \varnothing 9"/23 cm	SP00057200
2	1	Clamp Sleeve	SP00057300
3	1	Screw M5 \times 57	SP00099047
4	1	Wing Nut M5	SP00099040

Cymbal Holder

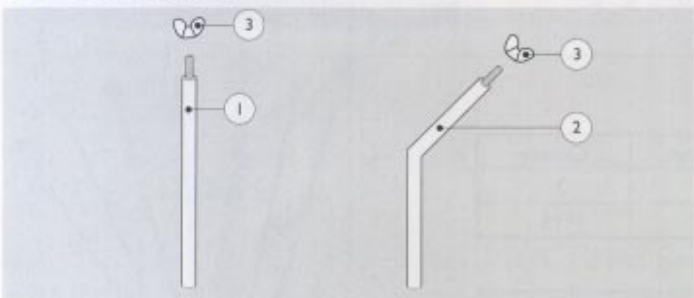

Cymbal Holder

No.	Qty.	Description	Item No.
1		Straight Cymbal Holder with Wing Nut M6	SP00058100
2		Angled Cymbal Holder with Wing Nut M6	SP00058200
3		Wing Screw M6	SP00099041

Multisound Holder

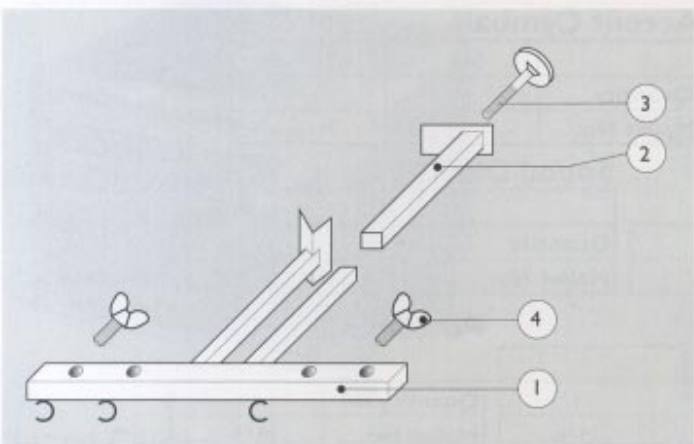

Multisound Holder

No.	Qty.	Description	Item No.
		Multisound Holder Complete	SP00058000
1	1	Clamp Rail	SP00058050
2	1	Clamping Bracket	SP00058060
3	1	Clamp Screw M8 \times 55	SP00099080
4	2	Wing Screw M6 \times 16	SP00099018

The mallets listed in the tables correspond to the listed gong sizes and types.

Planet Gongs

Gong	Earth	Sun	Pluto	Mercury	Mars	Saturn	Plat. Year	Jupiter	Day Sid.	Venus	Uranus	Neptun	Moon Syn.	Moon Sid.
Mallet No.	M6	M6	M6	M6	M6	M6	M6	M5	M5	M5	M5	M5	M5	M3

Symphonic Gongs

Gong Diameter	20"	22"	24"	26"	28"	30"	32"	34"	36"	38"	40"	50"	60"	80"
	51 cm	56 cm	61 cm	66 cm	71 cm	76 cm	81 cm	86 cm	91 cm	96 cm	102 cm	125 cm	150 cm	200 cm
Mallet No.	M2	M3	M3	M5	M5	M5	M6	M6	M6	M7	M7	M7	M8	M8

Sound Creation Gongs

Gong	No. 1	No. 2	No. 3	No. 3a	No. 3b	No. 3c	No. 4	No. 5	No. 6	No. 7	No. 8	No. 9	No. 10
Mallet No.	M4	M2	M4	M6	M7	M8	M3	M3	M4	M3	M2	M3	M4

Tuned Gongs

Gong	C2/C	C2#/Cis	D2/D	D2#/Dis	E2/E	F2/F	F2#/Fis	G2/G	G2#/Gis	A2/A	A2#/Ais	B2/H	C3/c	C3#/cis
Mallet No.	M6	M6	M6	M6	M5	M5	M5	M5	M5	M5	M5	M2	M2	M2

Gong	D3/d	D3#/dis	E3/e	F3/f	F3#/fis	G3/g	G3#/gis	A3/a	A3#/ais	B3/h	C4/c'	C4#/cis'	D4/dis'	D4#/dis'
Mallet No.	M2	M2	M2	M2	M2	M9	M9	M9	M9	M9	M9	M10	M10	M10

Gong	E4/e'	F4/f'	F4#/fis'	G4/g'	G4#/gis'	A4/a'	A4#/ais'	B4/h'	C5/c''	C5#/cis''	D5/d''	D5#/dis''	E5/e''	F5/f''
Mallet No.	M10	M10	M10	M10	M10	M10	M11	M11	M11	M11	M11	M11	M11	M11

Gong	F5/fis''	G5/g''	G5#/gis''	A5/a''	A5#/ais''	B5/h''	C6/c'''	C6#/cis'''	D6/d'''	D6#/dis'''	E6/e'''	F6/f'''
Mallet No.	M11	M11	M11	M11	M11	M11	M11	M11	M11	M11	M11	M11

Sound Mallets

For the corresponding sounds, the following mallets are available:

Crotales

	2 Octaves	1 Octave
Quantity	2	2
Mallet No.	M15	M15

Tuned Discs

	2 Octaves	1 Octave
Quantity	2	2
Mallet No.	M15	M15

Sound Plates

	Set	Individual
Quantity	2	1
Mallet No.	M12	M12

Cup Chimes

	Set	Individual
Quantity	2	1
Mallet No.	M14	M14



Accent Gongs

Gong	7"	10"	13"	22"
Diameter	18 cm	26 cm	33 cm	56 cm
Mallet No.	M11	M11	M10	M3

Accent Cymbals

	Set	Individual
Quantity	1	1
Mallet No.	M14	M14

Percussion Cymbal Tree

	Set	Individual
Quantity	1	1
Mallet No.	M14	M14

Finger Cymbals

Quantity	1
Mallet No.	M16

Sound Discs

	Set	Individual
Quantity	1	1
Mallet No.	M15	M15

Percussion Set

	Set				
Quantity	1	1	1	2	1
Mallet No.	M3	M11	M12	M14	M16

Rotosound

Quantity	1
Mallet No.	M14

Paiste Deco Gongs are hammered by hand according to tradition and fascinate through their wonderful exotic sound. Deco Gongs are available with or without Chinese Signs. They may also be specially inscribed with individual signs and logos. Deco Gongs are available with a floor stand or a wall hanger (black finish) and mallet.



The good shall come



The bad shall go

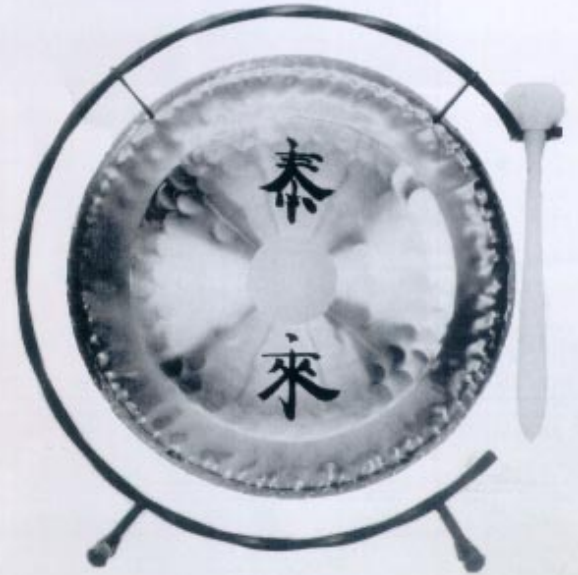

Deco Gongs

Gong Diameter	7"/18 cm	10"/26 cm	13"/33 cm	16"/40 cm
Floor Stand only	10"/25 cm	13"/33 cm	16"/40 cm	21"/54 cm
Wall Hanger only	4" × 3"/10 × 8 cm	4" × 3"/10 × 8 cm	5" × 4"/12 × 10 cm	8" × 4"/21 × 10 cm
Mallet only	M20	M21	M22	M23

Gong Cases

Gong Cases are made from synthetic materials or ply wood with synthetic material covering. Special molds are used inside to protect the gong edges. The case corners are protected by steel caps or corner guards. For handling either leather coated handles or collapsible steel handles are used. Gong Cases for one or more gongs are special orders and available only by request. Consult your local country's manufacturers. This may be of advantage with respect to delivery times and your cost.



Sound Cases for one or more Sounds are special orders and available only by request (see Gong Cases).

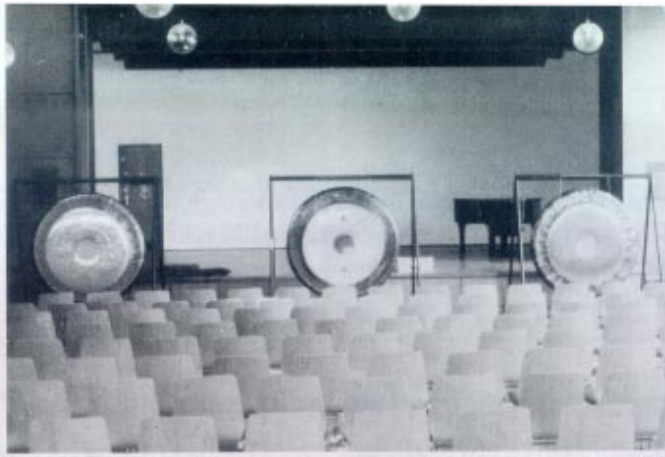

*Die Wirkung
von Gongklängen*

Es gibt

*Zusammen-
ziehende*

*is
dehnende*

*Klänge,
Störende
is
beruhigend,
Solche die
auf bestimmte
Körperorgane
einwirken.*

Kopf

Hals

Brust

Bauch

Gelenk

*Störung
Durch*

*Schall-
Wirkungen*

*Befriedigung
Sog*

