

M75LH Century Vibe

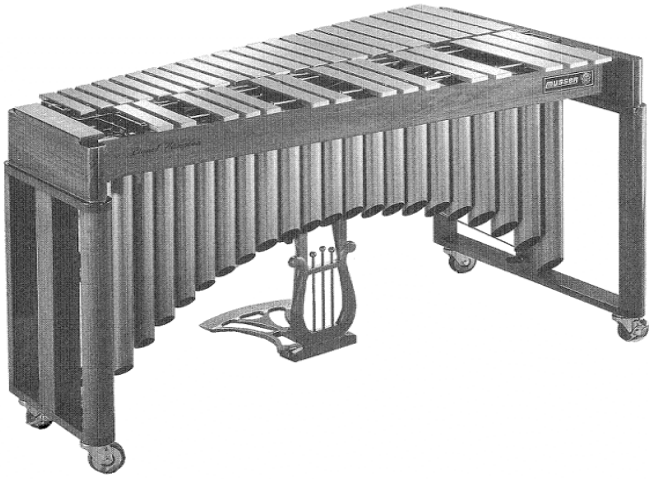

E3646

- E3646** Motor and control assy
- E36191** Motor w/connector
- E3634** Motor control unit
- E3617** ON/OFF switch
- E3632** Small potentiometer
- E3621** Control box mounting bracket
- E3631** Motor pulley
- E3630** Speed control knob
- E30601** Motor Panel w/Pins

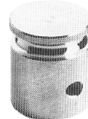

E3631

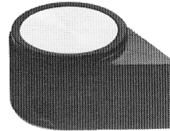

E3630



E0408



E0412

- E0412** Motor mounting Ring
- E0408** Vibe motor Belt
6" dia. (18.385 long)

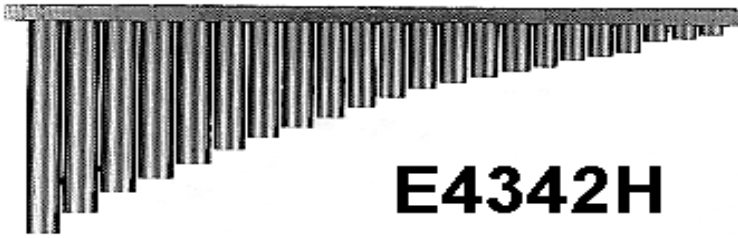

E4342H

- E4342H** Resonator and pulsator assembly, plain
- E4343H** Resonator and pulsator assembly, sharp

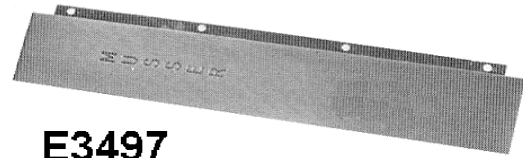

E3497

- E3497** Belt Cover plate
Will fit older models with some work.

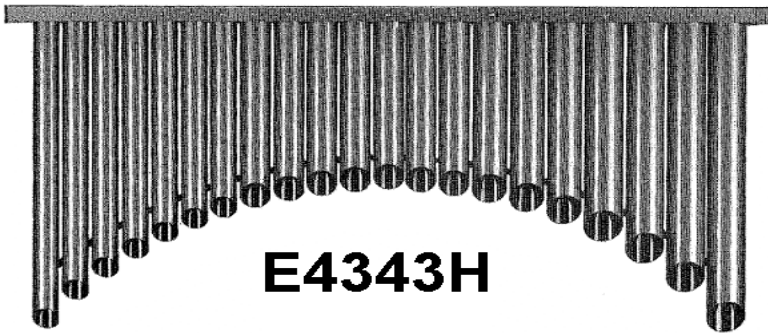

E4343H

- E4354** Pulsator shaft assembly, plain
- E4355** Pulsator shaft assembly, sharp
- E31541** Low end bearing bracket w/o nyliner
- E31561** Center bearing bracket w/o nyliner
- E31551** High end bearing bracket w/o nyliner
- E3157** Nyliner



E33281

- E33281** Pulsator shaft pulley
Older models used this on the motor also

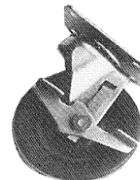

E0128



E0129

- E0128**
- E0129**

- 3" Caster w/brake
- 3" Caster, plain

M75LH parts, cont.

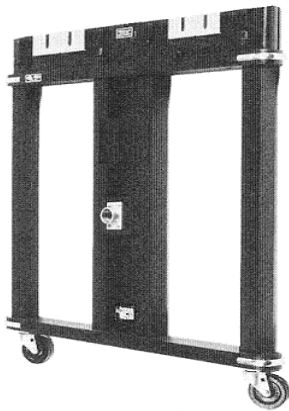

E41901H

E41901H Low end assembly

- E3125** Low end resonator plate, plain
- E3126** Low end resonator plate, sharp
- E3127** Low end resonator rubber (2 per)
- E3546** #1 LE rail bracket
- E34411** #2 LE rail bracket
- E34401** #3 LE rail bracket
- E3552** #4 LE rail bracket, top
- E3553** #4 LE rail bracket, bottom

E41911H High end assembly

- E3547** #1 HE rail bracket
- E3555** #4 HE rail bracket, top
- E3556** #4 HE rail bracket, bottom

- E3499H** Crossbar and Lyre assembly
- E97892H** Diagonal brace (2 required)
- P1534** Female "T" handle for braces



E3219H

E3219H Pedal and lower pullrod
E32262 Lower pullrod only



E9487

E9487 Knob for pullrod
E7323T Pedal felt (10 pk)

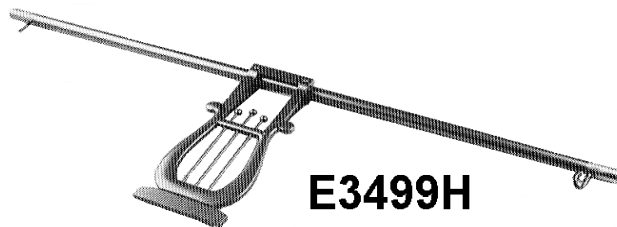

E3499H



E0900T

E0900T Saddle post (10pk)
40 per instrument



E0901T

E0901T Hook Post (10 pk)
40 per instrument



E0905

E0905 End Post
4 per inst, 1&4 rails



E0912

E0912 End Post
4 per inst, 2&3 rails



E0300T

E0300T Post insulator (10 pk)
88 per instrument

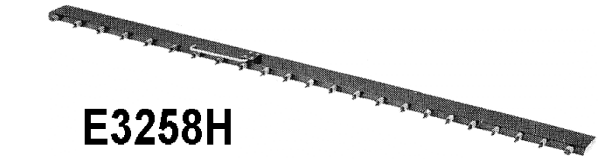

E3258H

E3258H Rail #1 (Closest to player)

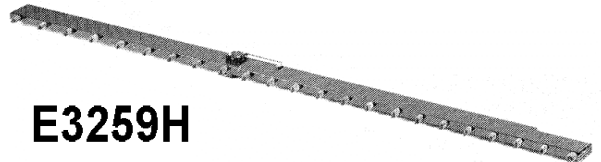

E3259H

E3259H Rail #2

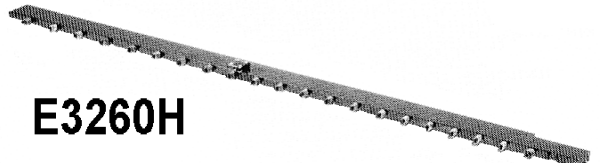

E3260H

E3260H Rail #3

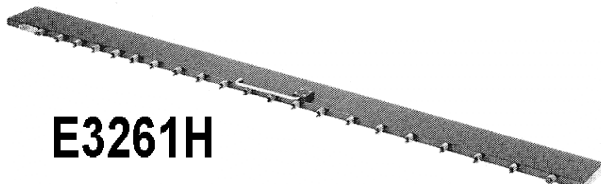

E3261H

E3261H Rail #4 (Closest to Audience)

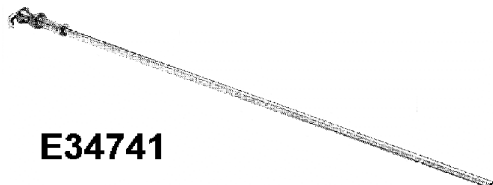

E34741

E34741 Upper pullrod

M75LH parts, cont.

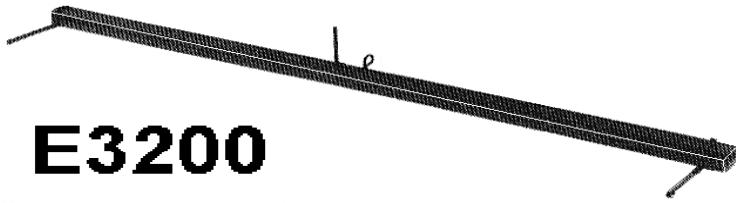

E3200

- E3200** Damper bar assembly
- E3215** Eye hook 1/4 20 x 2"
- E2455** Hex nut 1/4 20 (2 req to hold eye hook)
- E3202** Damper stud

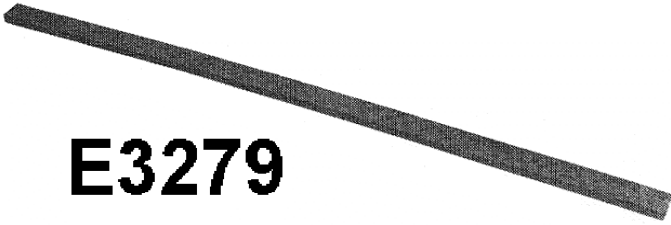

E3279

E3279 Damper felt, 1/2" x 1 1/2" x 51"

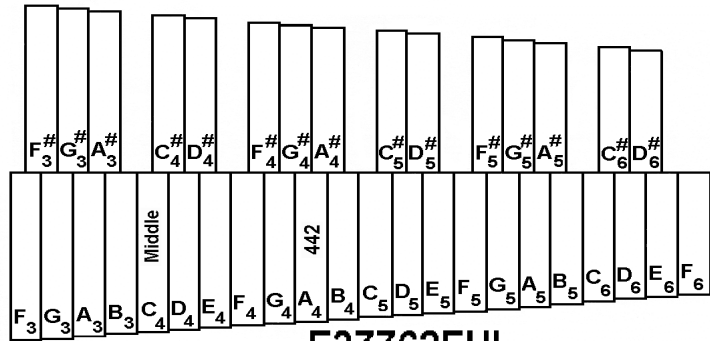

E37762FUL

- E37762FUL** Full set of bars for M75LH, tuned to A=442
 - E37762FULW0** Full set of bars for M75LH, tuned to A=440
A=442 is standard tuning.
 - E37762xxx** Individual bars.
- (Ex: Middle C = E37762CN4, 1/2 step up is E37762CS4)



E1902V

E1902V Pack of 2 springs
Order 2 packs for one instrument

E4441V Green bar cord
One pack does one instrument

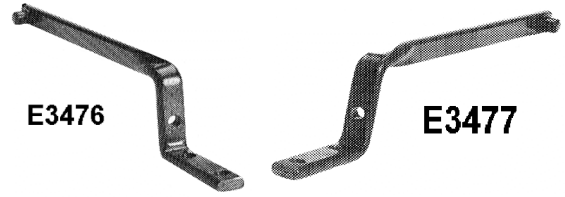

E3476

E3477

- E3476** Low end damper arm
- E3216** Mounting clip for E3476
- E3477** High end damper arm
- E3217** Mounting clip for E3477

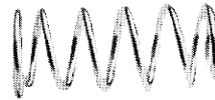

E32111



E3213

- E32111** Damper spring
- E3213** Damper Spring bracket

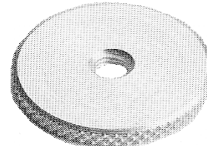

E32031



E3206

- E32031** Damper adjustment nut
- E3206** Felt Washer

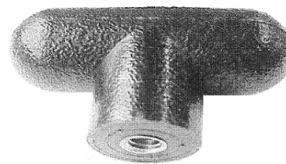

P1534



E2477

E2477 Wing nut
Used to lock damper spring

P1534 Female "T" handle for braces